

# CGHV96130F

130 W, 8.4 - 9.6 GHz, 50-ohm, Input/Output Matched GaN HEMT

## Description

Cree's CGHV96130F is a gallium nitride (GaN) High Electron Mobility Transistor (HEMT) on Silicon Carbide (SiC) substrates. This GaN Internally Matched (IM) FET offers excellent power added efficiency in comparison to other technologies. GaN has superior properties compared to silicon or gallium arsenide, including higher breakdown voltage, higher saturated electron drift velocity and higher thermal conductivity. GaN HEMTs also offer greater power density and wider bandwidths compared to GaAs transistors. This IM FET is available in a metal/ceramic flanged package for optimal electrical and thermal performance.

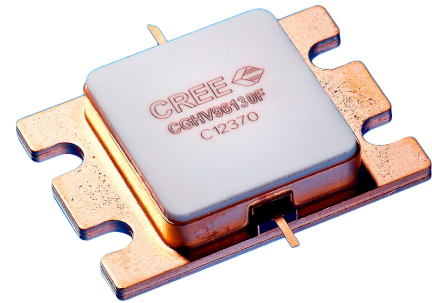

PN: CGHV96130F  
Package Type: 440217

## Typical Performance Over 8.4 - 9.6 GHz ( $T_c = 25^\circ\text{C}$ )

Parameter	8.4 GHz	8.6 GHz	8.8 GHz	9.0 GHz	9.2 GHz	9.4 GHz	9.6 GHz	Units
Linear Gain	13.6	13.1	13.3	13.5	13.8	13.0	11.8	dB
Output Power	184	173	173	168	163	165	153	W
Power Gain	8.7	8.4	8.4	8.3	8.0	8.2	7.8	dB
Power Added Efficiency	36	33	33	33	34	38	39	%

Note: Measured in CGHV96130F-AMP (838179) under 100  $\mu\text{s}$  pulse width, 10% duty, Pin 44.0 dBm (25.1 W)

### Features

- 8.4 - 9.6 GHz Operation
- 166 W  $P_{\text{OUT}}$  typical
- 7.5 dB Power Gain
- 42% Typical PAE
- 50 Ohm Internally Matched
- <0.3 dB Power Droop

### Applications

- Marine Radar
- Weather Monitoring
- Air Traffic Control
- Maritime Vessel Traffic Control
- Port Security

**Absolute Maximum Ratings (not simultaneous)**

Parameter	Symbol	Rating	Units	Conditions
Drain-source Voltage	$V_{DS}$	120	Volts	25 °C
Gate-source Voltage	$V_{GS}$	-10, +2	Volts	25 °C
Power Dissipation	$P_{DISS}$	222.0	Watts	Pulse
Storage Temperature	$T_{STG}$	-65, +150	°C	
Operating Junction Temperature	$T_J$	225	°C	
Maximum Drain Current <sup>1</sup>	$I_{DMAX}$	12	Amps	
Maximum Forward Gate Current	$I_{GMAX}$	28.8	mA	25 °C
Soldering Temperature <sup>2</sup>	$T_S$	245	°C	
Screw Torque	$\tau$	40	in-oz	
Thermal Resistance, Junction to Case	$R_{\theta JC}$	0.73	°C/W	Pulse Width = 100 $\mu$ s, Duty Cycle = 10%, 85 °C, $P_{DISS} = 173$ W
Case Operating Temperature <sup>2</sup>	$T_C$	-40, +150	°C	

## Notes:

<sup>1</sup> Current limit for long term, reliable operation<sup>2</sup> Refer to the Application Note on soldering at [wolfspeed.com/rf/document-library](http://wolfspeed.com/rf/document-library)<sup>3</sup> See also, the Power Dissipation De-rating Curve on Page 9**Electrical Characteristics (Frequency = 9.4 GHz unless otherwise stated;  $T_C = 25$  °C)**

Characteristics	Symbol	Min.	Typ.	Max.	Units	Conditions
<b>DC Characteristics<sup>1</sup></b>						
Gate Threshold Voltage	$V_{GS(TH)}$	-3.8	-3.0	-2.3	V	$V_{DS} = 10$ V, $I_D = 28.8$ mA
Gate Quiescent Voltage	$V_{GS(Q)}$	-	-2.7	-	V	$V_{DS} = 40$ V, $I_D = 1000$ mA
Saturated Drain Current <sup>2</sup>	$I_{DS}$	21.0	26.0	-	A	$V_{DS} = 6.0$ V, $V_{GS} = 2.0$ V
Drain-Source Breakdown Voltage	$V_{BD}$	100	-	-	V	$V_{GS} = -8$ V, $I_D = 28.8$ mA
<b>RF Characteristics<sup>3</sup></b>						
Small Signal Gain	S21	10.5	12.2	-	dB	$V_{DD} = 40$ V, $I_{DQ} = 1000$ mA, $P_{IN} = -20$ dBm
Input Return Loss 1	S11	-	-5.4	-	dB	$V_{DD} = 40$ V, $I_{DQ} = 1000$ mA, $P_{IN} = -20$ dBm, 8.4 - 9.4 GHz
Input Return Loss 2	S11	-	-5.6	-	dB	$V_{DD} = 40$ V, $I_{DQ} = 1000$ mA, $P_{IN} = -20$ dBm, 9.4 - 9.6 GHz
Output Return Loss	S22	-	-8.8	-	dB	$V_{DD} = 40$ V, $I_{DQ} = 1000$ mA, $P_{IN} = -20$ dBm
Power Output <sup>3,4</sup>	$P_{OUT}$	130	166	-	W	$V_{DD} = 40$ V, $I_{DQ} = 1000$ mA, $P_{IN} = 44$ dBm
Power Added Efficiency <sup>3,4</sup>	PAE	30	42	-	%	$V_{DD} = 40$ V, $I_{DQ} = 1000$ mA, $P_{IN} = 44$ dBm
Power Gain <sup>3,4</sup>	$P_G$	7.0	7.5	-	dB	$V_{DD} = 40$ V, $I_{DQ} = 1000$ mA, $P_{IN} = 44$ dBm
Output Mismatch Stress	VSWR	-	-	5:1	$\Psi$	No damage at all phase angles, $V_{DD} = 40$ V, $I_{DQ} = 1000$ mA,

## Notes:

<sup>1</sup> Measured on wafer prior to packaging<sup>2</sup> Scaled from PCM data<sup>3</sup> Measured in CGHV96100F2-TB (838179) under 100  $\mu$ s pulse width, 10% duty<sup>4</sup> Fixture loss de-embedded using the following offsets: Frequency = 9.4 GHz. Input = 0.5 dB and Output = 0.5 dB



**CGHV96130F Typical Performance**

**Figure 1. Small Signal Gain and Return Loss vs Frequency of CGHV96130F measured in CGHV96130F-AMP**

$V_{DS} = 40\text{ V}, I_{DQ} = 1000\text{ mA}$

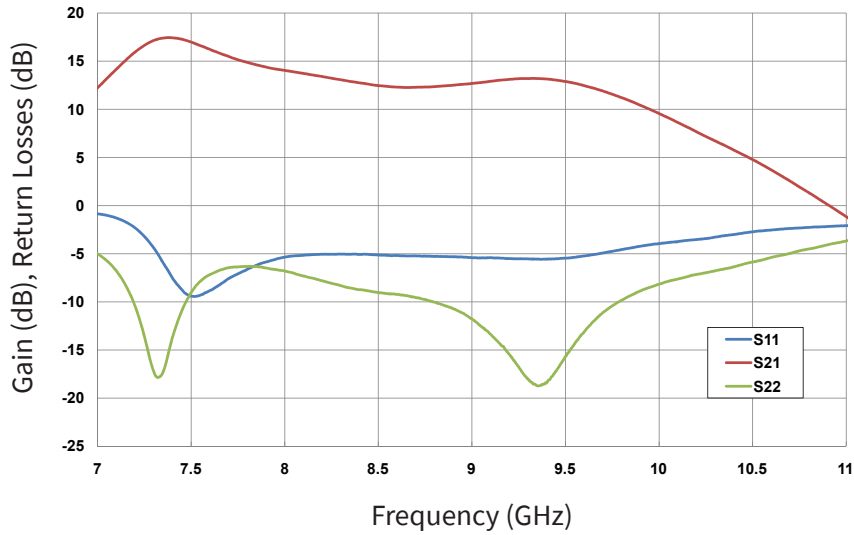

**Figure 2. Power Gain vs. Frequency and Input Power**

$V_{DD} = 40\text{ V}, \text{Pulse Width} = 100\ \mu\text{sec}, \text{Duty Cycle} = 10\%$

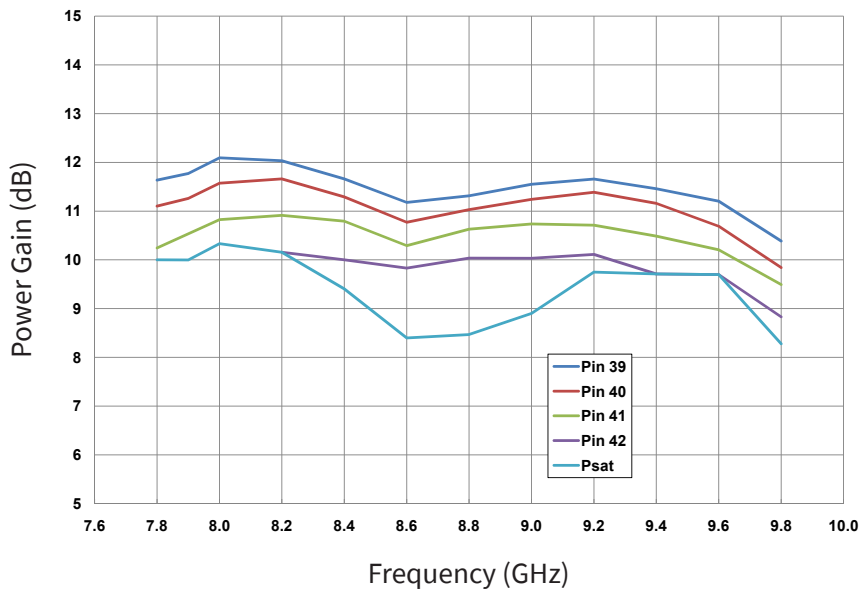



### CGHV96130F Typical Performance

**Figure 3. Output Power vs. Input Power**  
 $V_{DD} = 40\text{ V}$ , Pulse Width = 100  $\mu\text{sec}$ , Duty Cycle = 10%

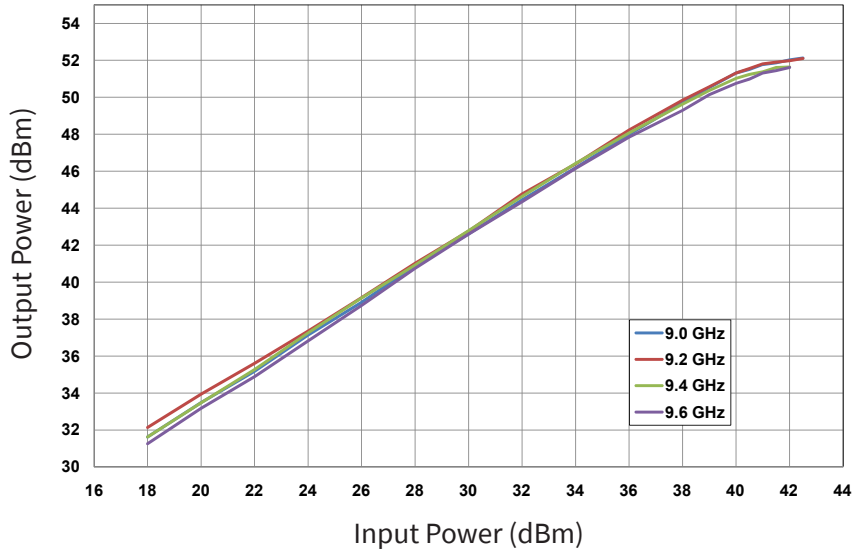

**Figure 4. Power Gain vs. Frequency and Input Power**  
 $V_{DD} = 40\text{ V}$ , Pulse Width = 100  $\mu\text{sec}$ , Duty Cycle = 10%

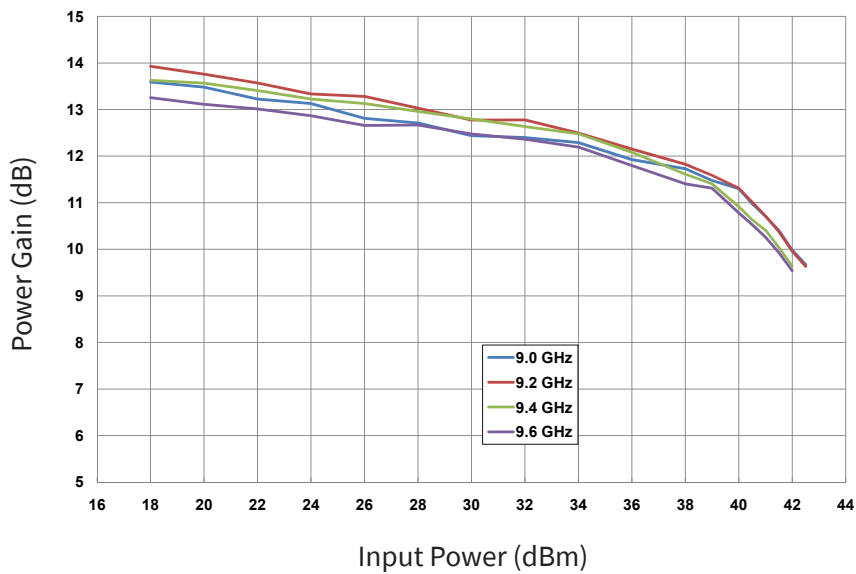



### CGHV96130F Typical Performance

**Figure 5. Power Added Efficiency vs. Input Power**  
 $V_{DD} = 40\text{ V}$ , Pulse Width = 100  $\mu\text{sec}$ , Duty Cycle = 10%

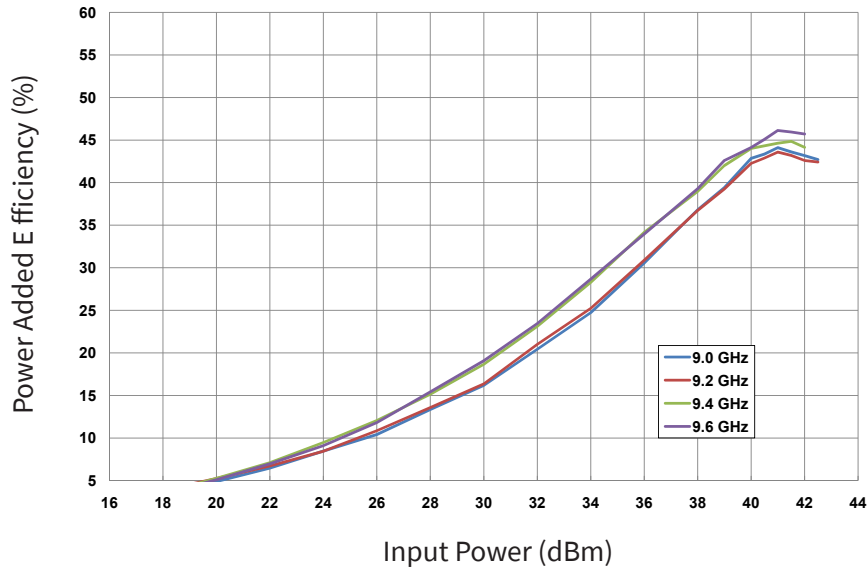

**Figure 6. Output Power vs. Time**  
 $V_{DD} = 40\text{ V}$ ,  $P_{IN} = 41\text{ dBm}$ , Duty Cycle = 10%

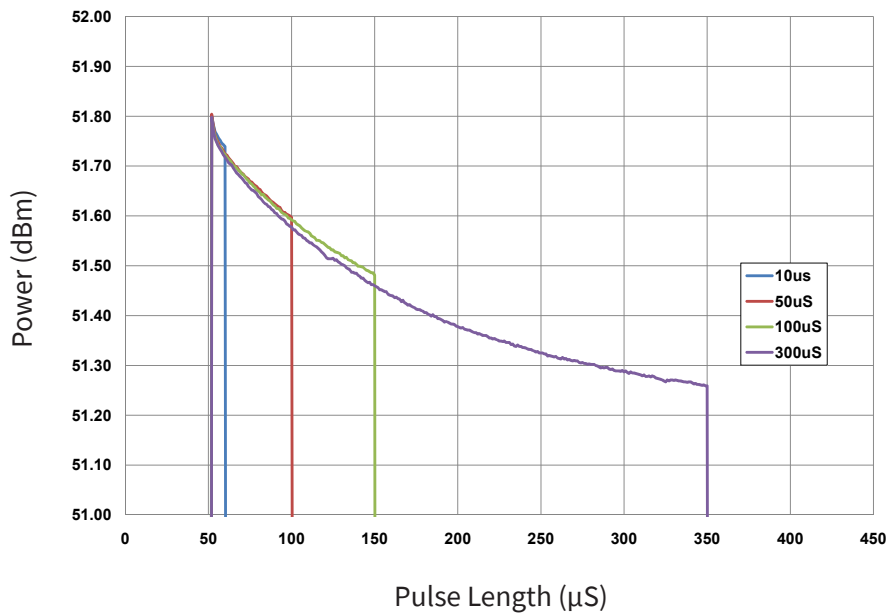



**CGHV96130F Typical Performance**

**Figure 7. Output Power vs. Input Power & Frequency**  
 $V_{DD} = 40\text{ V}$ , Pulse Width = 100  $\mu\text{sec}$ , Duty Cycle = 10%

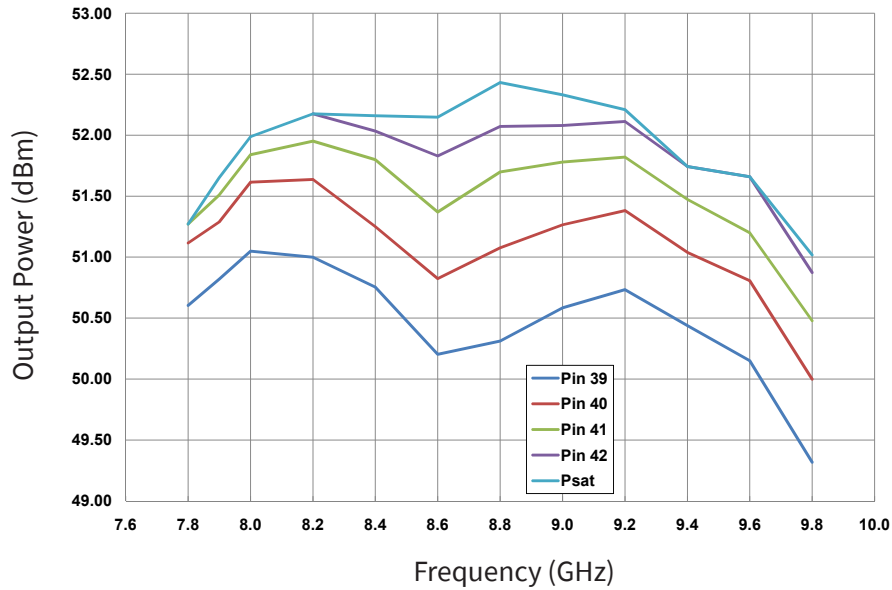

**Figure 8. Power Added Efficiency vs. Input Power & Frequency**  
 $V_{DD} = 40\text{ V}$ , Pulse Width = 100  $\mu\text{sec}$ , Duty Cycle = 10%

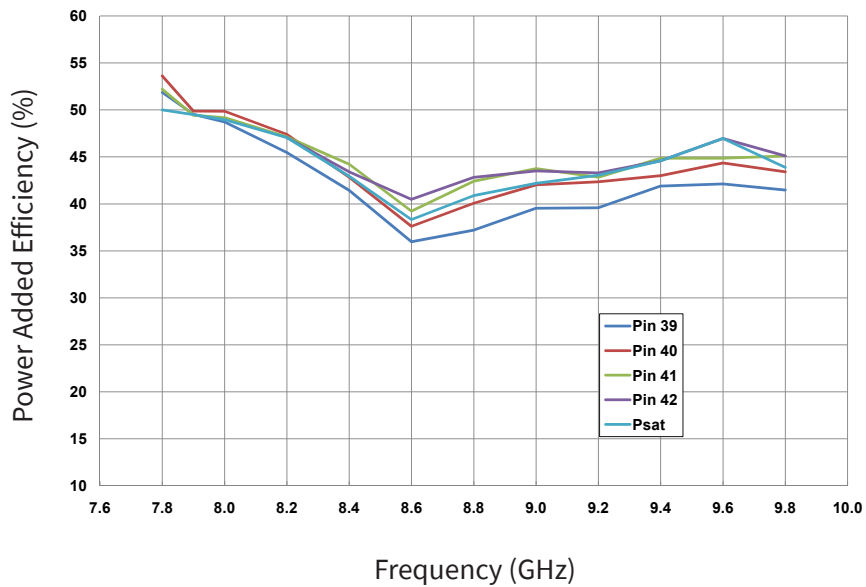

**CGHV96130F-AMP Demonstration Amplifier Circuit Bill of Materials**

Designator	Description	Qty
R1	RES, 47 OHM +/-1%, 1/16 W, 0603, SMD	1
C1, C11	CAP, 1.6pF, +/- 0.1 pF, 200V, 0402, ATC 600L	2
C2, C12	CAP, 1.0pF, +/- 0.1 pF, 200V, 0402 ATC 600L	2
C3, C13	CAP, 10 pF +/-5%, 0603, ATC	2
C4, C14	CAP, 470 pF +/-5%, 100 V, 0603	2
C5, C15	CAP, 33,000 pF, 0805, 100 V, X7R	2
C6	CAP, 10 uF, 16 V, TANTALUM	1
C18	CAP, 470 uF +/-20%, ELECTROLYTIC	1
J1,J2	CONNECTOR, SMA, PANEL MOUNT JACK, FLANGE, 4-HOLE, BLUNT POST, 20MIL	2
J3	CONNECTOR, HEADER, RT>PLZ .1CEN LK 9POS	1
J4	CONNECTOR, SMB, STRAIGHT JACK	1
-	PCB, TEST FIXTURE, TACONICS RF35P, 20 MIL THK, 440210 PKG	1
-	2-56 SOC HD SCREW 1/4 SS	4
-	#2 SPLIT LOCKWASHER SS	4
Q1	CGHV96130F	1



### CGHV96130F-AMP Demonstration Amplifier Circuit Schematic

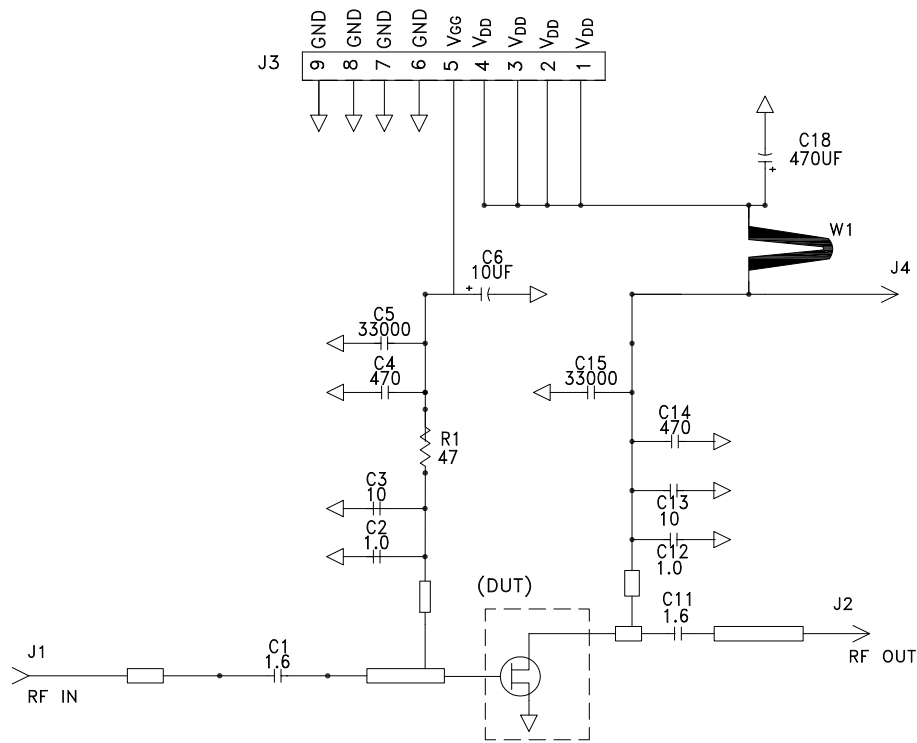

### CGHV96130F-AMP Demonstration Amplifier Circuit Outline

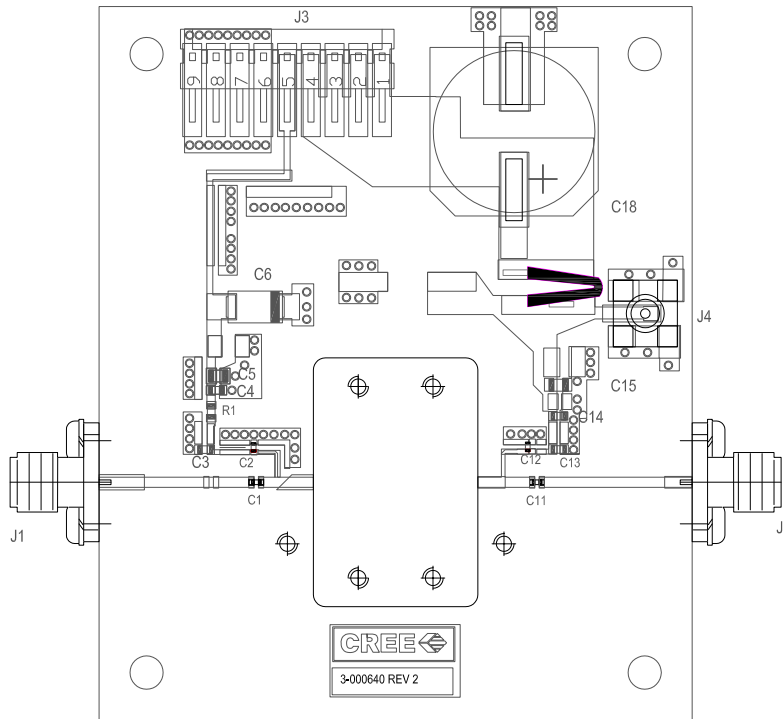





### CGHV96130F Power Dissipation De-rating Curve

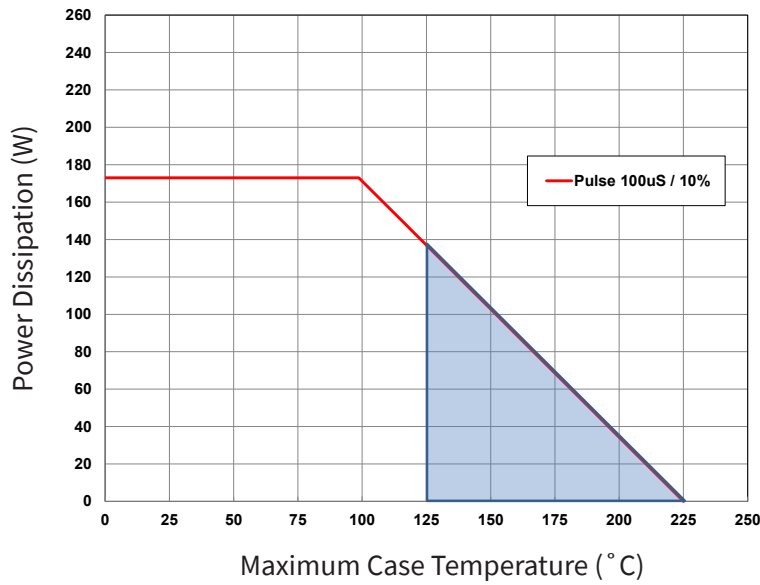

Note 1 : Shaded area exceeds Maximum Case Operating Temperature (See Page 2)

### CGHV96130F Transient Curve

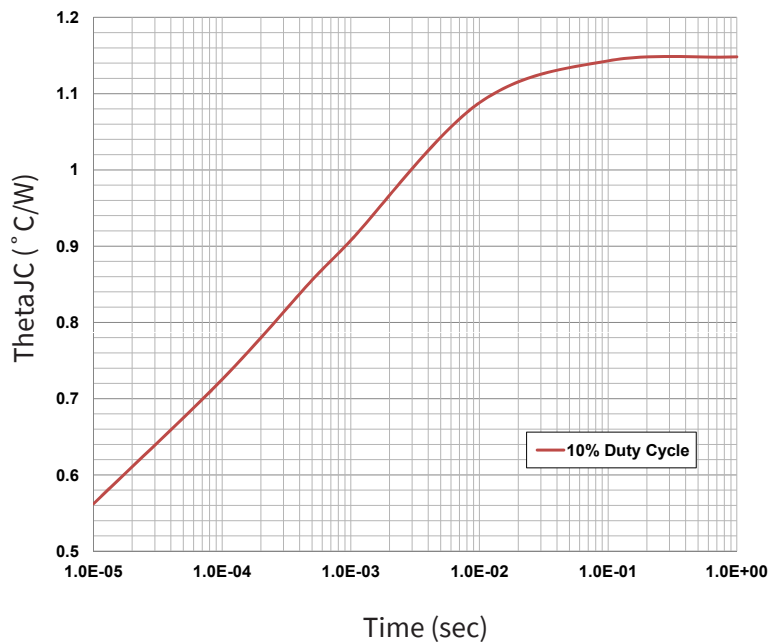

### Electrostatic Discharge (ESD) Classifications

Parameter	Symbol	Class	Test Methodology
Human Body Model	HBM	1A > 250 V	JEDEC JESD22 A114-D
Charge Device Model	CDM	II (200 < 500 V)	JEDEC JESD22 C101-C

**Product Dimensions CGHV96130F (Package Type — 440217)**

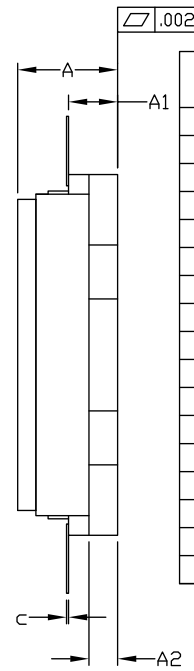
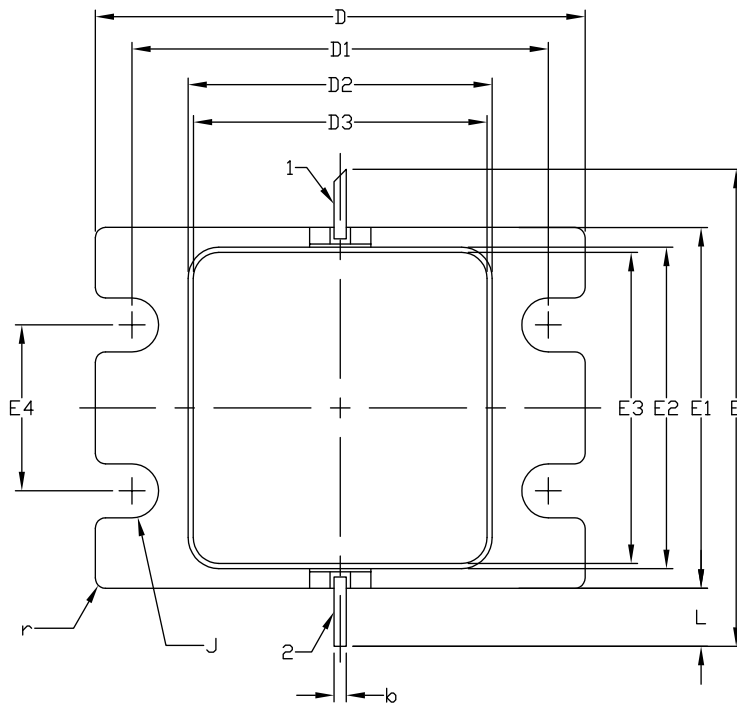

DIM	INCHES		MILLIMETERS		NOTES
	MIN	MAX	MIN	MAX	
A	0.188	0.198	4.78	5.03	
A1	0.088	0.100	2.24	2.54	2x
A2	0.049	0.061	1.24	1.55	
b	0.022	0.026	0.56	0.66	2x
c	0.002	0.006	0.05	0.15	
D	0.935	0.955	23.75	24.26	
D1	0.797	0.809	20.24	20.55	2x
D2	0.581	0.593	14.76	15.06	
D3	0.563	0.571	14.30	14.50	
E	0.906		23.01		REF
E1	0.679	0.691	17.25	17.55	
E2	0.604	0.616	15.34	15.65	
E3	0.586	0.594	14.88	15.09	
E4	0.309	0.321	7.85	8.15	2x
J	∅0.097	∅0.107	∅2.46	∅2.72	4x
L	0.090	0.130	2.29	3.30	2x
r	0.02 TYP		0.51 TYP		12x



**Part Number System**

**CGHV96130F**

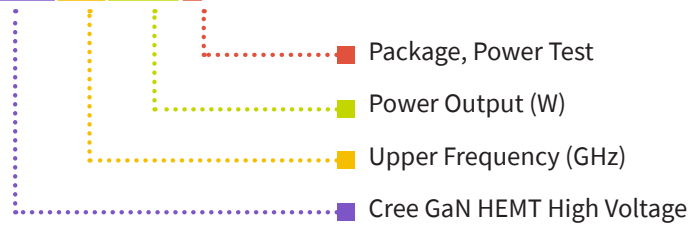

**Table 1.**

Parameter	Value	Units
Upper Frequency <sup>1</sup>	9.6	GHz
Power Output	130	W
Package	Flange	-

**Note<sup>1</sup>:** Alpha characters used in frequency code indicate a value greater than 9.9 GHz. See Table 2 for value.

**Table 2.**

Character Code	Code Value
A	0
B	1
C	2
D	3
E	4
F	5
G	6
H	7
J	8
K	9
Examples:	1A = 10.0 GHz 2H = 27.0 GHz

**Product Ordering Information**

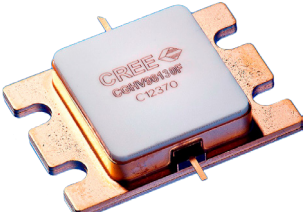
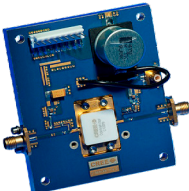
Order Number	Description	Unit of Measure	Image
CGHV96130F	GaN HEMT	Each	
CGHV96130F-AMP	Test board with GaN HEMT	Each	



For more information, please contact:

4600 Silicon Drive  
Durham, North Carolina, USA 27703  
[www.wolfspeed.com/RF](http://www.wolfspeed.com/RF)

Sales Contact  
[RFSales@wolfspeed.com](mailto:RFSales@wolfspeed.com)

RF Product Marketing Contact  
[RFMarketing@wolfspeed.com](mailto:RFMarketing@wolfspeed.com)

## Notes

---

### Disclaimer

Specifications are subject to change without notice. Cree, Inc. believes the information contained within this data sheet to be accurate and reliable. However, no responsibility is assumed by Cree for any infringement of patents or other rights of third parties which may result from its use. No license is granted by implication or otherwise under any patent or patent rights of Cree. Cree makes no warranty, representation or guarantee regarding the suitability of its products for any particular purpose. “Typical” parameters are the average values expected by Cree in large quantities and are provided for information purposes only. These values can and do vary in different applications and actual performance can vary over time. All operating parameters should be validated by customer’s technical experts for each application. Cree products are not designed, intended or authorized for use as components in applications intended for surgical implant into the body or to support or sustain life, in applications in which the failure of the Cree product could result in personal injury or death or in applications for planning, construction, maintenance or direct operation of a nuclear facility.