



**RESISTORS
ATTENUATORS
TERMINATIONS
DETECTORS**



Over 30 years, Res-Net Microwave, Inc. has been delivering high performance RF/Microwave components for:

- **Wireless Communications**
- **Broadcast**
- **Medical**
- **Test and measurement equipment**
- **Custom engineering solutions**



Dependable, Reliable, Rugged, High Performance RF/Microwave Components for Mission-Critical Applications:

- **Radar**
- **Microwave Radio**
- **Telemetry**
- **Aerospace/Space**
- **Avionics**
- **Shipboard systems**
- **EW systems**
- **Unmanned Vehicles**
- **Electronic Counter Measures**



WELCOME



Res-Net Microwave, Inc. is an internationally recognized leader in design and manufacturing of high power and high frequency passive components. Since its founding in 1985, the company has manufactured resistors, terminations and attenuators for the most challenging military, commercial and space applications. Our team excels in new product design, quality and customer service.

The staff members at RES-NET MICROWAVE, as well as our representatives, welcome the opportunity to provide any engineering assistance in the use of our products. We feel confident you will be pleased with our product quality, cost effectiveness, and the service rendered by our RES-NET organization.

Res-Net Microwave, Inc. is committed to our quality assurance program and delivering products of the highest quality to our customers.

*Electro Technik Industries welcomes you
to visit their family of companies.
See back cover for contact information.*

Nova Microwave, Inc.
Star Microwave, Inc.
Arizona Capacitors, Inc.
Custom Suppression, Inc.
Plastic Capacitors, Inc.
Tepro of Florida, Inc.
Vamistor Corporation
HYMEG Corporation
Hytronics Corporation
Raycom Electronics, Inc.
Inductive Technologies, Inc. (I-Tech)
Winatic Corporation



INDEX-a

	PAGE
Tech Data	<u>1</u>
ATTENUATORS	<u>2</u>
Chip	
Surface Mount	<u>3-4, 7</u>
Planar	<u>5</u>
Ground Wrap	<u>6</u>
Wire-Bondable	<u>8</u>
Tab & Cover	<u>9 - 12</u>
Flange	<u>13 - 19</u>
Coaxial	
Conduction Cooled	<u>20 - 26</u>
Convection Cooled	<u>27 - 33</u>
RESISTORS	<u>34</u>
Chip	
Style R	<u>35</u>
Style W	<u>36</u>
Style Z	<u>37 - 38</u>
Tab & Cover	<u>39</u>
Flange	<u>40 - 43</u>
Rod	<u>44- 45</u>
Disc	<u>46</u>
TERMINATIONS	<u>47</u>
Chip	
Style T	<u>48 - 49</u>
Style Z	<u>50 - 51</u>
Tab & Cover	<u>52 - 53</u>

a



Toll Free: 800.526.0704
Phone: 727.530.9555

PO Box 18802
Clearwater, FL 33762
www.resnetmicrowave.com

INDEX-b

	PAGE
Flange	<u>54 - 57</u>
Stripline Flange	<u>58 - 61</u>
Coaxial	
Conduction Cooled	<u>62 - 70</u>
Convection Cooled	<u>71 - 78</u>
Cylindrical	<u>79</u>
CVD DIAMOND COMPONENTS	<u>80</u>
Chip Resistors	<u>81 - 82</u>
Chip Terminations	<u>83 - 86</u>
Flange Terminations	<u>87</u>
Coaxial Terminations	<u>88</u>
THERMAL JUMPERS	<u>89</u>
CVD Diamond	<u>90</u>
Aluminum Nitride (ALN)	<u>91 - 92</u>
Beryllium Oxide (BeO)	<u>93</u>
ZERO-BIASED SCHOTTKY DIODE DETECTORS	
RNZD Series	<u>94 & 96</u>
RNZD Series "High Sensitivity"	<u>95</u>
CERTIFICATIONS & WARRANTY	<u>97</u>
DEDICATION	<u>98</u>
RES-NET & SUBSIDIARY INFORMATION	<u>99</u>

b

Conversion of VSWR, Reflection Coefficient, Insertion Loss, and Power Transmission

VSWR	Refl Coef	RL	Insertion L	Power Trs	Power Ret	VSWR	Refl Coef	RL	Insertion L	Power Trs	Power Ret
1.00	0.000	∞	0.000	100.00%	0.00%	1.68	0.254	11.9	0.289	93.56%	6.44%
1.01	0.005	46.1	0.000	100.00%	0.00%	1.70	0.259	11.7	0.302	93.28%	6.72%
1.02	0.010	40.1	0.000	99.99%	0.01%	1.72	0.265	11.5	0.315	92.99%	7.01%
1.03	0.015	36.6	0.001	99.98%	0.02%	1.74	0.270	11.4	0.329	92.71%	7.29%
1.04	0.020	34.2	0.002	99.96%	0.04%	1.76	0.275	11.2	0.342	92.42%	7.58%
1.05	0.024	32.3	0.003	99.94%	0.06%	1.78	0.281	11.0	0.356	92.13%	7.87%
1.06	0.029	30.7	0.004	99.92%	0.08%	1.80	0.286	10.9	0.370	91.84%	8.16%
1.07	0.034	29.4	0.005	99.89%	0.11%	1.82	0.291	10.7	0.384	91.54%	8.46%
1.08	0.038	28.3	0.006	99.85%	0.15%	1.84	0.296	10.6	0.398	91.25%	8.75%
1.09	0.043	27.3	0.008	99.81%	0.19%	1.86	0.301	10.4	0.412	90.96%	9.04%
1.10	0.048	26.4	0.010	99.77%	0.23%	1.88	0.306	10.3	0.426	90.66%	9.34%
1.11	0.052	25.7	0.012	99.73%	0.27%	1.90	0.310	10.2	0.440	90.37%	9.63%
1.12	0.057	24.9	0.014	99.68%	0.32%	1.92	0.315	10.0	0.454	90.07%	9.93%
1.13	0.061	24.3	0.016	99.63%	0.37%	1.94	0.320	9.9	0.468	89.78%	10.22%
1.14	0.065	23.7	0.019	99.57%	0.43%	1.96	0.324	9.8	0.483	89.48%	10.52%
1.15	0.070	23.1	0.021	99.51%	0.49%	1.98	0.329	9.7	0.497	89.19%	10.81%
1.16	0.074	22.6	0.024	99.45%	0.55%	2.00	0.333	9.5	0.512	88.89%	11.11%
1.17	0.078	22.1	0.027	99.39%	0.61%	2.10	0.355	9.0	0.584	87.41%	12.59%
1.18	0.083	21.7	0.030	99.32%	0.68%	2.20	0.375	8.5	0.658	85.94%	14.06%
1.19	0.087	21.2	0.033	99.25%	0.75%	2.30	0.394	8.1	0.732	84.48%	15.52%
1.20	0.091	20.8	0.036	99.17%	0.83%	2.40	0.412	7.7	0.807	83.04%	16.96%
1.23	0.103	19.7	0.046	98.94%	1.06%	2.50	0.429	7.4	0.881	81.63%	18.37%
1.24	0.107	19.4	0.050	98.85%	1.15%	2.60	0.444	7.0	0.956	80.25%	19.75%
1.25	0.111	19.1	0.054	98.77%	1.23%	2.70	0.459	6.8	1.030	78.89%	21.11%
1.26	0.115	18.8	0.058	98.68%	1.32%	2.80	0.474	6.5	1.103	77.56%	22.44%
1.27	0.119	18.5	0.062	98.59%	1.41%	2.90	0.487	6.2	1.177	76.27%	23.73%
1.28	0.123	18.2	0.066	98.49%	1.51%	3.00	0.500	6.0	1.249	75.00%	25.00%
1.29	0.127	17.9	0.070	98.40%	1.60%	3.20	0.524	5.6	1.393	72.56%	27.44%
1.30	0.130	17.7	0.075	98.30%	1.70%	3.40	0.545	5.3	1.534	70.25%	29.75%
1.32	0.138	17.2	0.083	98.10%	1.90%	3.60	0.565	5.0	1.672	68.05%	31.95%
1.34	0.145	16.8	0.093	97.89%	2.11%	3.80	0.583	4.7	1.806	65.97%	34.03%
1.36	0.153	16.3	0.102	97.67%	2.33%	4.00	0.600	4.4	1.938	64.00%	36.00%
1.38	0.160	15.9	0.112	97.45%	2.55%	4.50	0.636	3.9	2.255	59.50%	40.50%
1.40	0.167	15.6	0.122	97.22%	2.78%	5.00	0.667	3.5	2.553	55.56%	44.44%
1.42	0.174	15.2	0.133	96.99%	3.01%	6.00	0.714	2.9	3.100	48.98%	51.02%
1.44	0.180	14.9	0.144	96.75%	3.25%	7.00	0.750	2.5	3.590	43.75%	56.25%
1.46	0.187	14.6	0.155	96.50%	3.50%	8.00	0.778	2.2	4.033	39.51%	60.49%
1.48	0.194	14.3	0.166	96.25%	3.75%	9.00	0.800	1.9	4.437	36.00%	64.00%
1.50	0.200	14.0	0.177	96.00%	4.00%	10.00	0.818	1.7	4.807	33.06%	66.94%
1.52	0.206	13.7	0.189	95.74%	4.26%	12.00	0.846	1.5	5.466	28.40%	71.60%
1.54	0.213	13.4	0.201	95.48%	4.52%	14.00	0.867	1.2	6.040	24.89%	75.11%
1.56	0.219	13.2	0.213	95.21%	4.79%	16.00	0.882	1.1	6.547	22.15%	77.85%
1.58	0.225	13.0	0.225	94.95%	5.05%	18.00	0.895	1.0	7.002	19.94%	80.06%
1.60	0.231	12.7	0.238	94.67%	5.33%	20.00	0.905	0.9	7.413	18.14%	81.86%
1.62	0.237	12.5	0.250	94.40%	5.60%	25.00	0.923	0.7	8.299	14.79%	85.21%
1.64	0.242	12.3	0.263	94.12%	5.88%	30.00	0.935	0.6	9.035	12.40%	87.51%
1.66	0.248	12.1	0.276	93.84%	6.16%	40.00	0.951	0.4	10.214	9.52%	90.48%

Notes

ATTENUATORS



RF attenuators are the basic building blocks widely used in RF & Microwave designs. Attenuators reduce (attenuate) the power of an electrical signal. Attenuators are designed with a specific characteristic impedance (i.e. 50 Ohms) so they don't alter the signal waveform. They can be fixed, variable or switched.

There are many different ways to make an RF attenuator. Most common are fixed attenuators, which are made from resistors to provide specific attenuation value, typically expressed in dB (decibels). On the other hand, variable attenuators are used to continuously vary the signal level and are made with PIN diodes. For higher frequencies, attenuators are designed to improve impedance match in the circuit.

Res-Net Microwave, Inc. offers a full line of high power RF attenuators including: chip, surface mount, tab & cover, flange mounted, coaxial, convection and conduction cooled types. Our attenuators have high attenuation accuracy, and flat broadband frequency response. Standard attenuation values range from 0 to 40dB.

Res-Net attenuators are capable of handling power up to 2kW and frequencies up to 40GHz. For best power and frequency performance, our attenuators are made from: Alumina, Beryllium Oxide (BeO), Aluminum Nitrate (ALN), and Chemical Vapor Deposition (CVD) diamond substrate materials.



Features:

- Frequency Range from DC to 40GHz
- Power Handling up to 2000 Watts
- Excellent Attenuation Accuracy
- Alumina, ALN, BeO or CVD Diamond Substrates
- Temperature Range: -55°C to +150°C
- High Reliability Versions Available

Applications:

- High Power Amplifiers
- Isolators
- Filters
- Impedance Matching
- Signal Sampling

CHIP ATTENUATORS

SURFACE MOUNT RNCA05-XXW3

General Specifications

Substrate: Alumina
Resistive Film: Thick Film
Terminals: Silver over Nickel



Part Number	Impedance (Ohms)	Frequency (GHz)	VSWR (max)	Temperature (°C)	Power (W)
RNCA05-XXW3	50 Ohms	DC-4 4-8 8-14	1.25:1 1.35:1 1.50:1	-55 TO +150	0.1

Attenuation Accuracy (dB)			
XX = dB	DC – 4 GHz	4 – 8 GHz	8 – 12 GHz
0 – 3	±0.3	±0.5	±0.5
4 – 6	±0.4	±0.5	±0.5
7 – 10	±0.5	±0.5	±0.75
11 – 15	±0.75	-3.5, +0.5	-3.5, +0.5
16 - 20	±1.0	-4.0, +0.5	-6.0, +1.0

RNCA05-XXW3

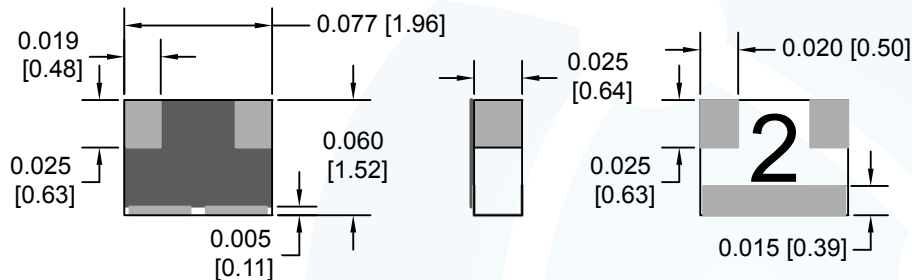

Dimensions are in inches [mm], Tolerance: .XXX = ±0.010, .XX = ±0.015

Ordering Information:

Example: **RNCA05- XX -W3**

Series ————— ↑
dB Value ————— ↑
3 Wraps ————— ↑

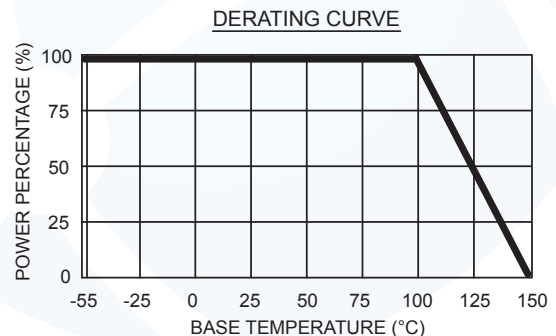

CHIP ATTENUATORS

SURFACE MOUNT

RNCAXXVW3



General Specifications

Substrate: Alumina
 Resistive Material: Thick Film
 Terminals: Silver Over Nickel
 Temperature Range: -55°C to +150°C
 Power Rating: 1 Watt



Attenuation (dB)	Attenuation Accuracy (dB)	Frequency (GHz)	VSWR (max)
0 - 9	+0.5	DC-4.0 4.0-8.0	1.25:1 1.35:1
10 - 12	±1.0	DC-4.0 4.0-8.0	1.25:1 1.35:1
13 - 14	-2.0/+0.5	DC-4.0 4.0-8.0	1.25:1 1.35:1
15 - 18	-3.0/+0.5	DC-4.0 4.0-8.0	1.25:1 1.35:1
19 - 20	-4.0/+0.5	DC-4.0 4.0-8.0	1.35:1 1.35:1

RNCAXXVW3

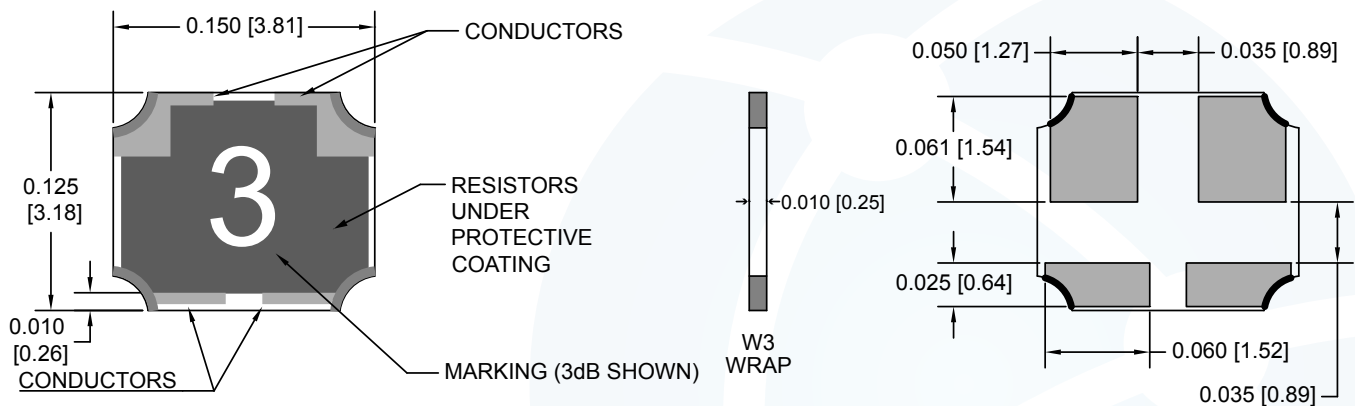

Dimensions are in inches [mm], Tolerance: .XXX = ±0.010, .XX = ±0.015

Ordering Information:

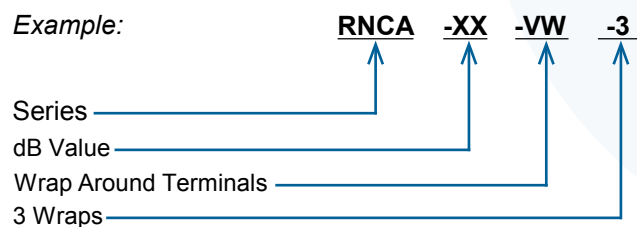

DERATING CURVE

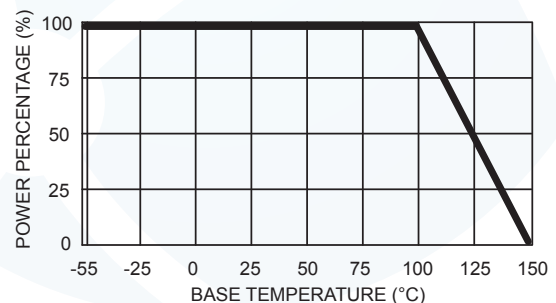

CHIP ATTENUATORS

PLANAR RNCA2-XX

General Specifications

Substrate: Alumina
 Resistive Material: Thick Film
 Terminals: Silver Over Nickel
 Temperature Range: -55°C to +150°C
 Power Rating: 2 Watts



Attenuation (dB)	Attenuation Accuracy (dB)	Frequency (GHz)	VSWR (max)
0 – 3	±0.3 ±0.5 ±0.5	DC-4.0 4.0-8.0 8.0-12.4	1.25:1 1.35:1 1.50:1
4 – 6	±0.4 ±0.5 ±0.5	DC-4.0 4.0-8.0 8.0-12.4	1.25:1 1.35:1 1.50:1
7 – 10	±0.5 ±0.5 ±0.7	DC-4.0 4.0-8.0 8.0-12.4	1.25:1 1.35:1 1.50:1
11 – 15	±0.75 -3.0/+0.5 -3.5/+0.5	DC-4.0 4.0-8.0 8.0-12.4	1.25:1 1.35:1 1.50:1
16 – 20	±1.0 -4.0/+0.5 -4.0/+0.5	DC-4.0 4.0-8.0 8.0-12.4	1.25:1 1.35:1 1.50:1

RNCA2-XX

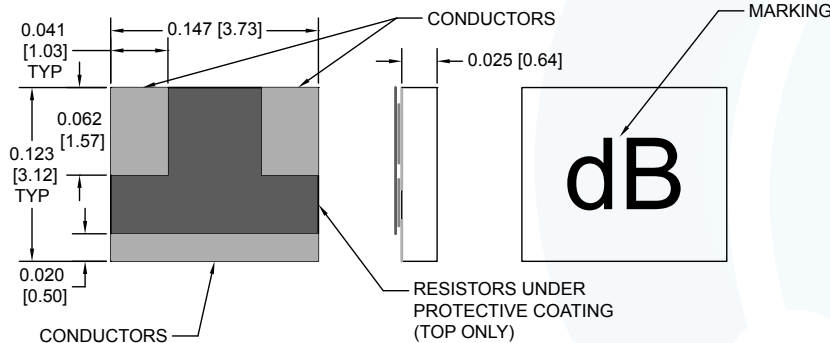

DERATING CURVE

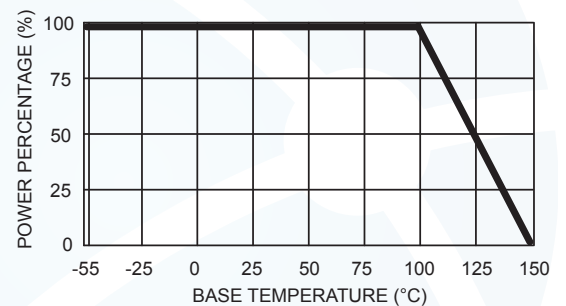

Ordering Information:

Example: **RNCA2 -XX**

Series → RNCA2
 dB Value → XX
 Planar (No designation after dB Value)

Dimensions are in inches [mm], Tolerance: .XXX = ±0.010,
 .XX = ±0.015

CHIP ATTENUATORS

GROUND WRAP

RNCA2-XXVW



General Specifications

Substrate: Alumina
 Resistive Material: Thick Film
 Terminals: Silver Over Nickel
 Temperature Range: -55°C to +150°C
 Power Rating: 2 Watts

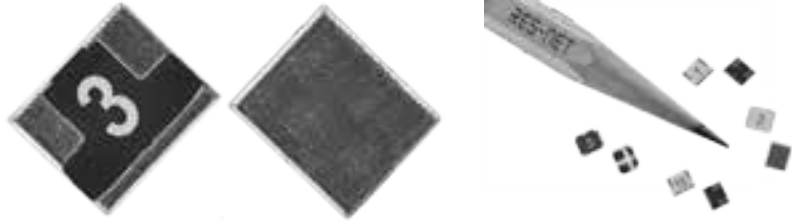

Attenuation (dB)	Attenuation Accuracy (dB)	Frequency (GHz)	VSWR (max)
0 - 3	±0.3 ±0.5	DC-4.0 4.0-8.0	1.25:1 1.50:1
4 - 6	±0.4 ±0.5	DC-4.0 4.0-8.0	1.25:1 1.50:1
7 - 10	±0.5 ±0.5	DC-4.0 4.0-8.0	1.25:1 1.50:1
11 - 15	±0.75 -3.0/+0.5	DC-4.0 4.0-8.0	1.25:1 1.50:1
16 - 20	±1.0 -4.0/+0.5	DC-4.0 4.0-8.0	1.25:1 1.50:1

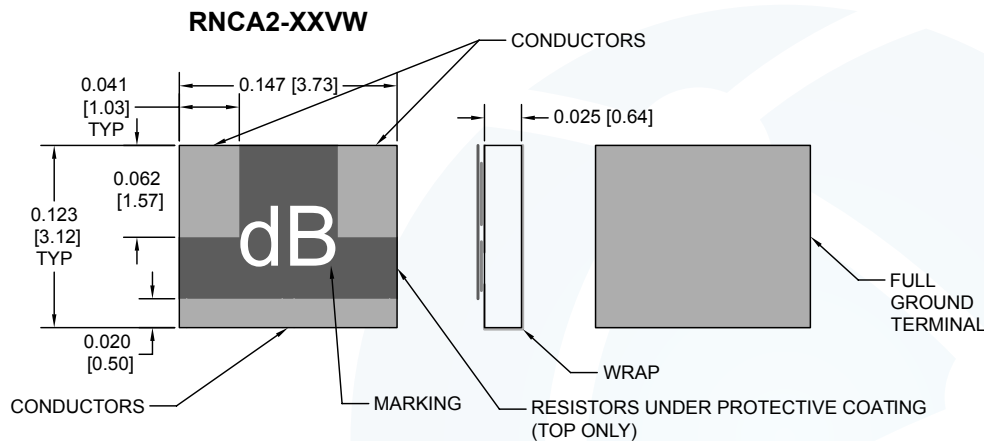

Dimensions are in inches [mm], Tolerance: .XXX = ±0.010, .XX = ±0.015

Ordering Information:

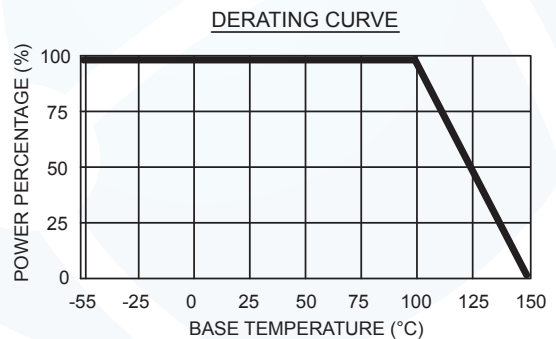
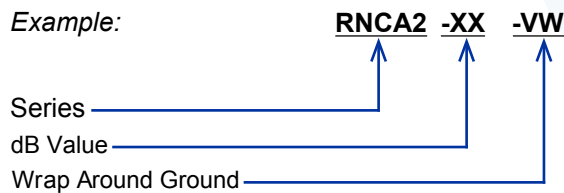

CHIP ATTENUATORS

SURFACE MOUNT RNCA2-XXVW3

General Specifications

Substrate: Alumina
 Resistive Material: Thick Film
 Terminals: Silver Over Nickel
 Temperature Range: -55°C to +150°C
 Power Rating: 2 Watts

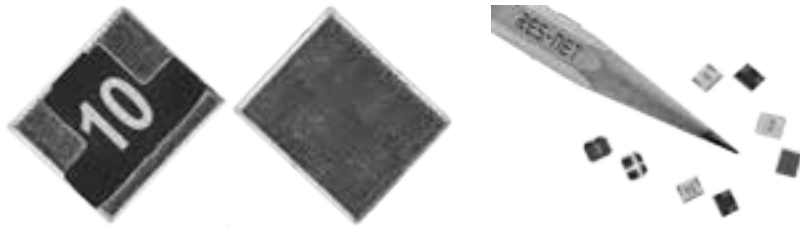

Attenuation (dB)	Attenuation Accuracy (dB)	Frequency (GHz)	VSWR (max)
0 – 3	±0.3 ±0.5	DC-4.0 4.0-8.0	1.25:1 1.50:1
4 – 6	±0.4 ±0.5	DC-4.0 4.0-8.0	1.25:1 1.50:1
7 – 10	±0.5 ±0.5	DC-4.0 4.0-8.0	1.25:1 1.50:1
11 – 15	±0.75 -3.0/+0.5	DC-4.0 4.0-8.0	1.25:1 1.50:1
16 – 20	±1.0 -4.0/+0.5	DC-4.0 4.0-8.0	1.25:1 1.50:1

RNCA2-XXVW3

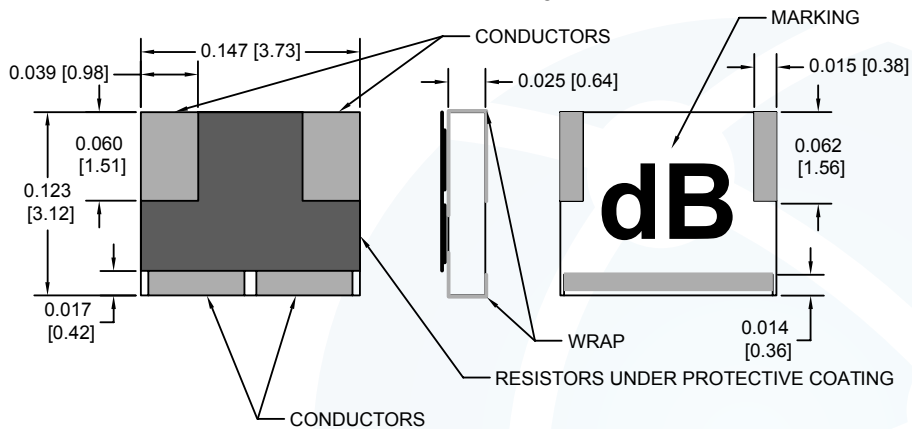

Ordering Information:

Example: **RNCA2 -XX -VW -3**

Series ↑

dB Value ↑

Wrap Around Terminals ↑

3 Wraps ↑

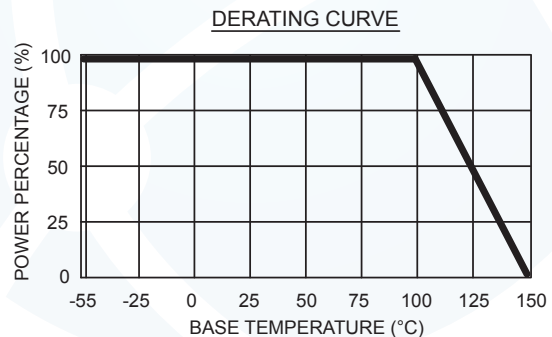

CHIP ATTENUATORS

WIRE BONDABLE TERMINALS

RNCA2-XXVWB



General Specifications

Substrate: Alumina
 Resistive Material: Thick Film
 Terminals: Wire Bondable Gold
 (See Ordering Information Below)
 Temperature Range: -55°C to +150°C
 Power Rating: 2 Watts

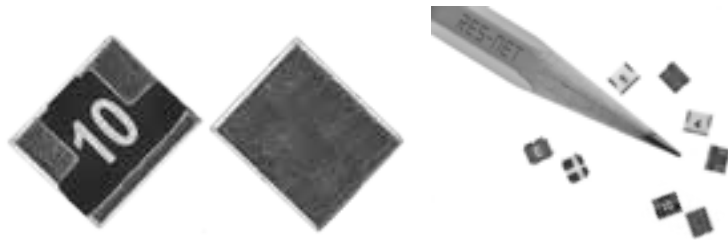

Attenuation (dB)	Attenuation Accuracy (dB)	Frequency (GHz)	VSWR (max)
0 – 3	±0.3 ±0.5	DC-4.0 4.0-8.0	1.25:1 1.50:1
4 – 6	±0.4 ±0.5	DC-4.0 4.0-8.0	1.25:1 1.50:1
7 – 10	±0.5 ±0.5	DC-4.0 4.0-8.0	1.25:1 1.50:1
11 – 15	±0.75 -3.0/+0.5	DC-4.0 4.0-8.0	1.25:1 1.50:1
16 - 20	±1.0 -4.0/+0.5	DC-4.0 4.0-8.0	1.25:1 1.50:1

RNCA2-XXVWB

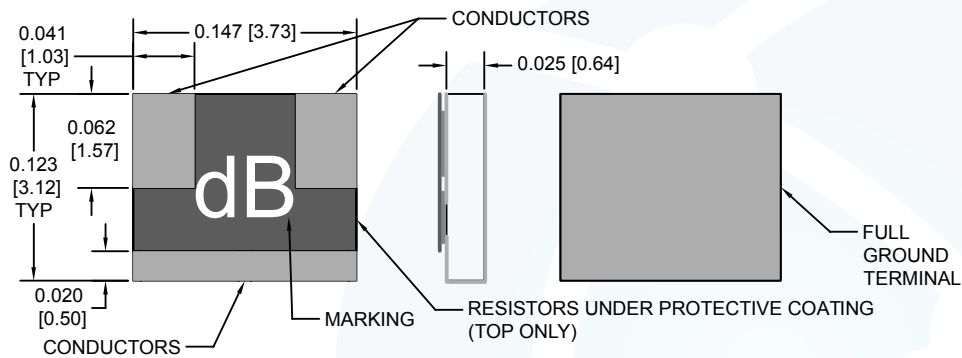

Ordering Information:

Example:

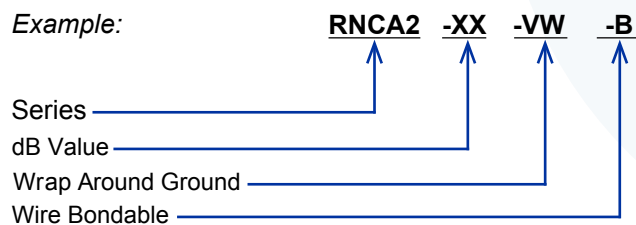

DERATING CURVE

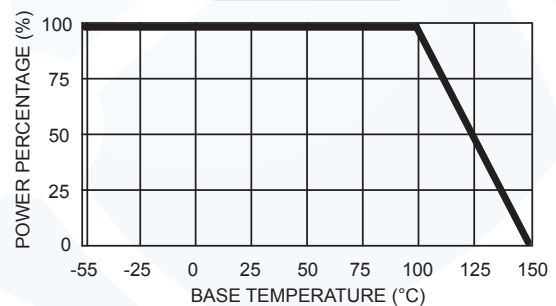

General Specifications

Substrate: Beryllium Oxide
 Resistive Material: Thick Film
 Tabs: Pure Silver or Silver Plated Beryllium Copper
 Cover: Alumina



Part Number	Attenuation (dB)	Attenuation Accuracy (dB)		Power (W)	VSWR (max)	
		DC – 1.0 GHz	1.0 – 2.5 GHz		DC – 2.0 GHz	2.0 - 2.4GHz
RPCA10-dBC	0 – 5	±0.5	±0.5	10	1.15:1	1.25:1
	6 – 9	±0.5	±0.5			
	10 – 15	±0.5	±1.0			
	16 – 20	±0.5	±1.0			
	21 – 30	±1.0	±1.0			
RPCA20-dBC	0 – 5	±0.5	±0.5	20	1.15:1	1.35:1
	6 – 9	±0.5	±0.5			
	10 – 15	±0.5	±1.0			
	16 – 20	±0.5	±1.0			
	21 – 30	±1.0	±1.0			

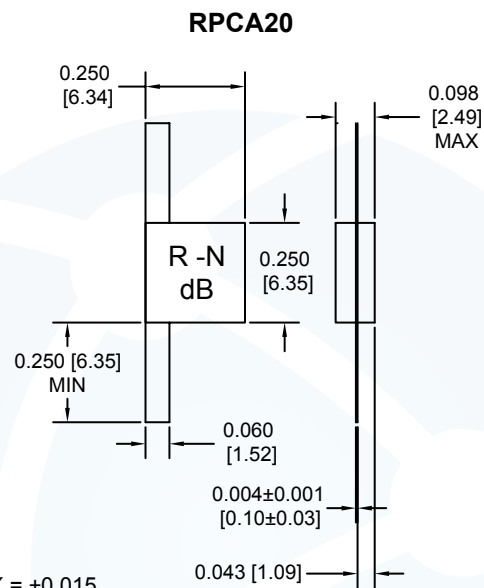
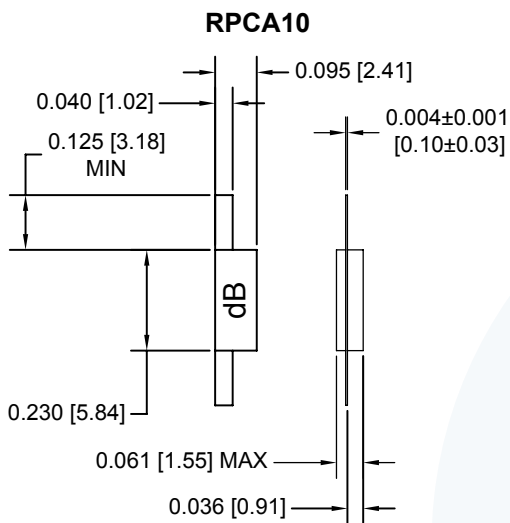

Dimensions are in inches [mm], Tolerance: .XXX = ±0.010, .XX = ±0.015

Ordering Information:

Example:

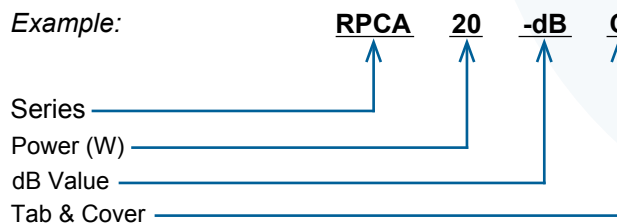

DERATING CURVE

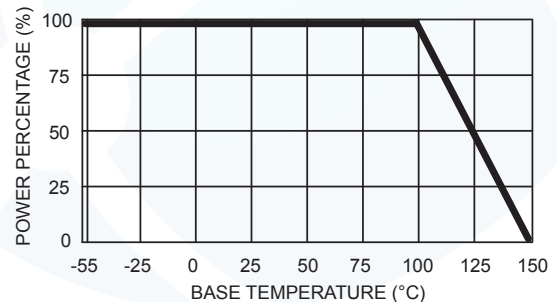

ATTENUATORS TAB & COVER



General Specifications

Substrate: Beryllium Oxide
Resistive Material: Thick Film
Tabs: Pure Silver or Silver Plated Beryllium Copper
Cover: Alumina

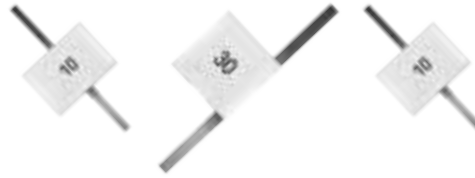

Part Number	Attenuation (dB)	Attenuation Accuracy (dB)			Power (W)	VSWR (max)			
		DC – 1.0 GHz	1.0 – 2.5 GHz	2.5 – 4.0 GHz		DC – 0.5 GHz	0.5 – 1 GHz	1.0 – 2.5 GHz	2.5 – 4.0 GHz
RPCA30-dBC	1 – 5	±0.3	±0.5	±0.5	30	1.15:1	1.15:1	1.25:1	1.35:1
	6 – 9	±0.3	±0.5	±0.7					
	10 – 15	±0.4	±0.5	±1.0					
	16 – 20	±0.5	±0.6	±1.0					
	20 – 30	±0.75	±1.0						
RPCA50-dBC	1 – 5	±0.5	±0.5		50	1.15:1	1.20:1		
	6 – 9	±0.3	±0.5						
	10 – 15	±0.4	±0.7						
	16 – 20	±0.5	±1.0						
	20 – 30	±0.5	±1.5						

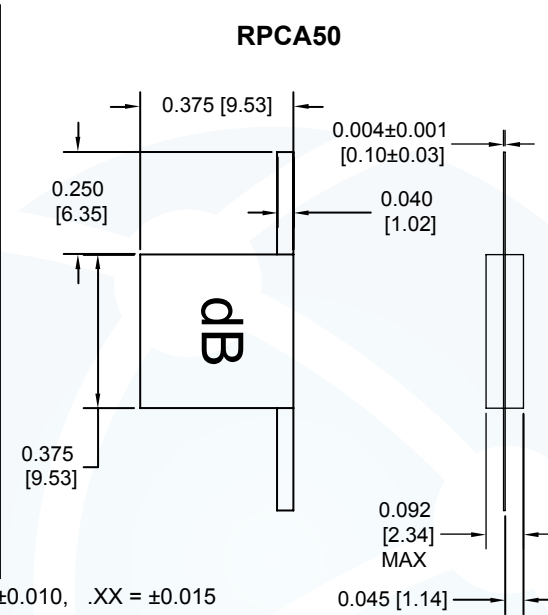
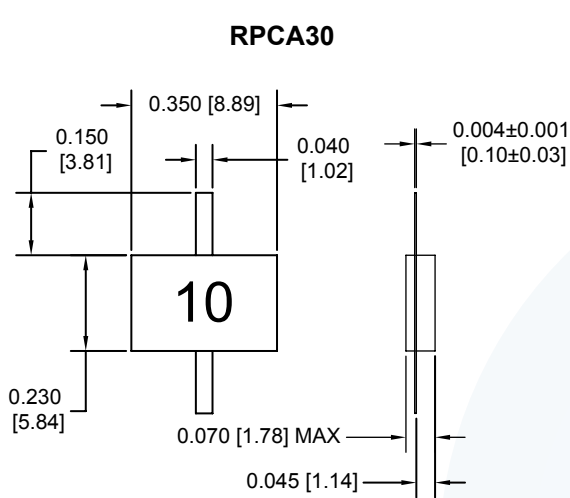

Dimensions are in inches [mm], Tolerance: .XXX = ±0.010, .XX = ±0.015

Ordering Information:

Example:

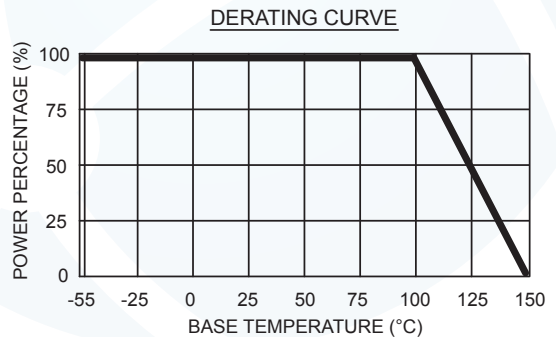
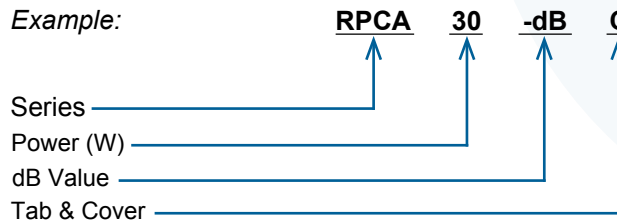

General Specifications

Substrate: Beryllium Oxide
 Resistive Material: Thick Film
 Tabs: Pure Silver or Silver Plated Beryllium Copper
 Cover: Alumina



Part Number	Attenuation (dB)	Attenuation Accuracy (dB)			Power (W)	VSWR (max)		
		DC – 1.0 GHz	1.0 – 2.0 GHz	2.0 – 3.0 GHz		DC – 1.0 GHz	1.0 – 2.0 GHz	2.0 – 3.0 GHz
RPCA100-dBC	0 - 20	±0.3	±0.5		100	1.15:1	1.25:1	
RPCA125-dBC	1 – 10 11 – 20 21 - 30	±0.3 ±0.4 ±0.5	±0.4 ±0.6 ±0.75	±0.6 ±0.75	125	1.15:1	1.20:1	1.25:1

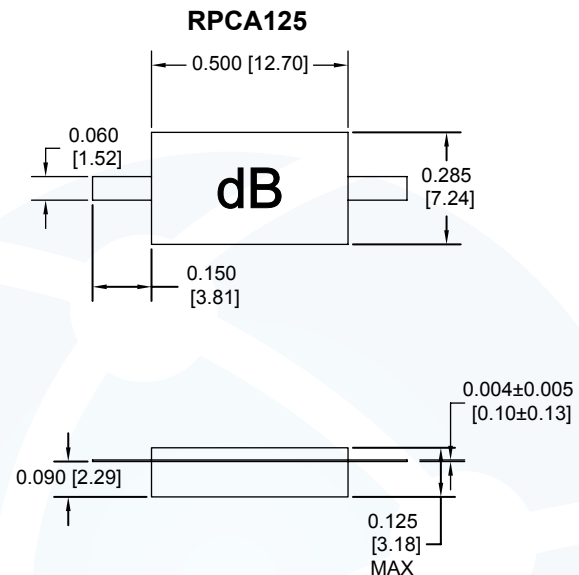
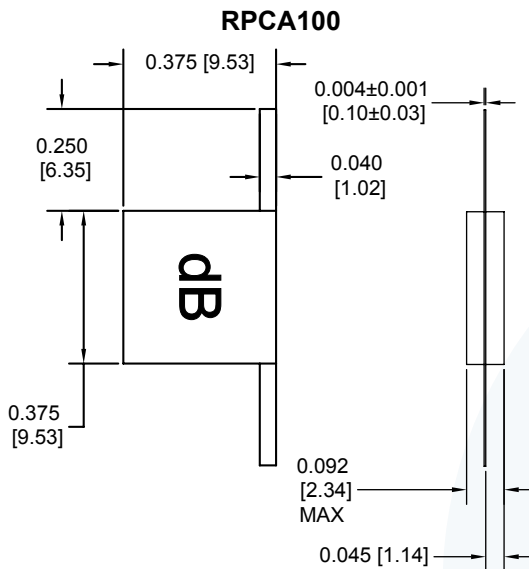

Dimensions are in inches [mm], Tolerance: .XXX = ±0.010, .XX = ±0.015

Ordering Information:

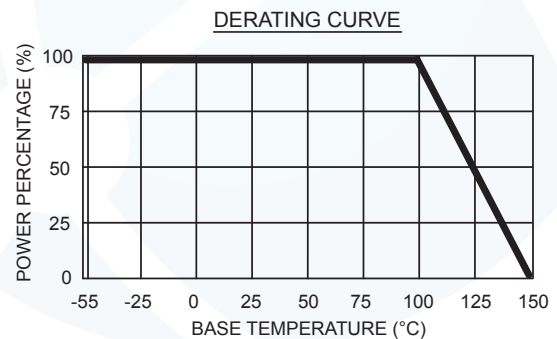
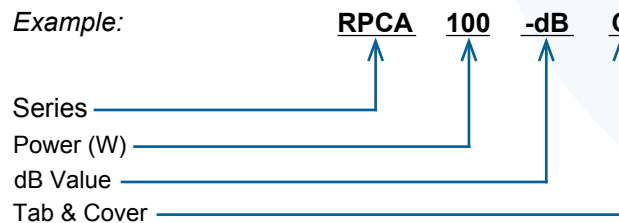

ATTENUATORS TAB & COVER



General Specifications

Substrate: Beryllium Oxide
Resistive Material: Thick Film
Tabs: Pure Silver or Silver Plated Beryllium Copper
Cover: Alumina



P/N	Attenuation (dB)	Attenuation Accuracy (dB)		Power (W)	VSWR (max)
		DC – 0.5 GHz	0.5 – 1.0 GHz		DC – 1.0 GHz
RPCA250-dBC	1 – 10	±0.3	±0.5	250	1.15:1
	11 – 20	±0.3	±0.75		
	21 – 30	±0.3	±1.0		

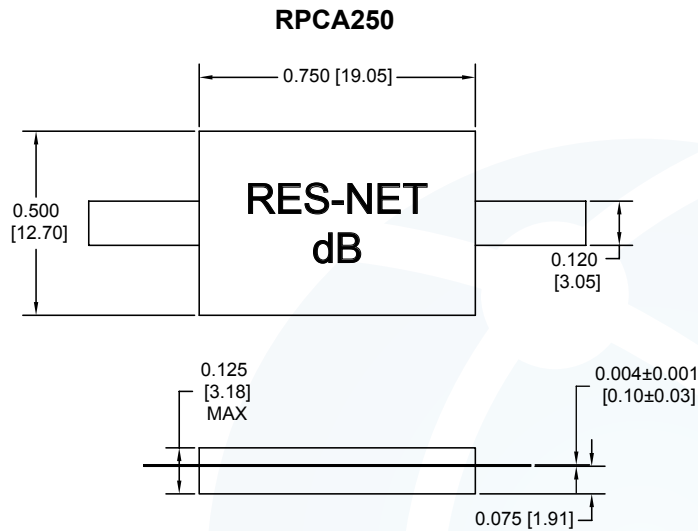

Dimensions are in inches [mm], Tolerance: .XXX = ±0.010, .XX = ±0.015

Ordering Information:

Example:

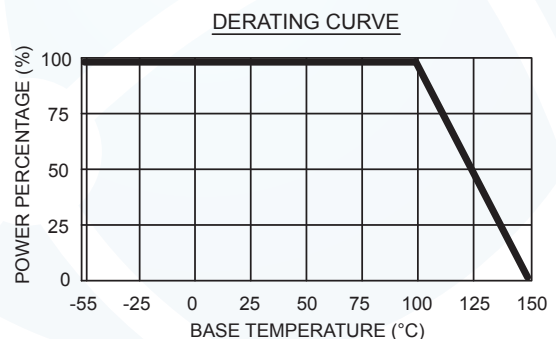
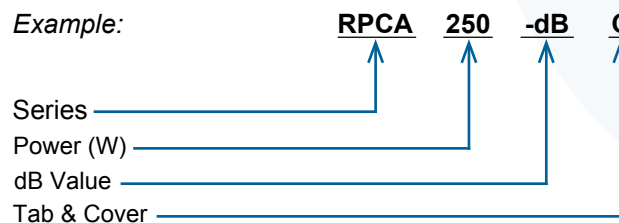

FLANGE ATTENUATORS

General Specifications

Substrate: Beryllium Oxide
Resistive Film: Thick Film
Tabs: Silver Plated Beryllium Copper
Flange: Nickel Plated Copper

Cover: Alumina
Impedance: 50 Ohms
Tolerance: $\pm 5\%$
Operating Temperature:
 -55°C to $+150^{\circ}\text{C}$



Part Number	Power (W)	Frequency (GHz)	VSWR (max)	Attenuation Accuracy (dB)	
RPA10-dB	10	DC-2.0 2.0-4.0	1.15:1 1.25:1	0-10	± 0.5
				11-20	± 1.0

RPA10-dB

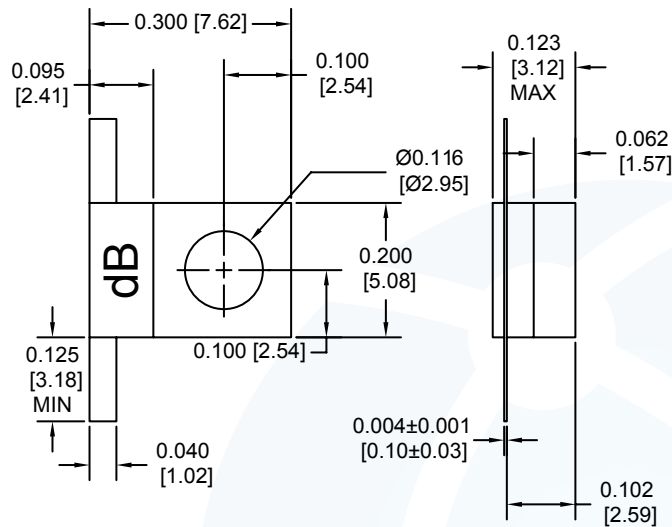

Dimensions are in inches [mm], Tolerance: .XXX = ± 0.010 , .XX = ± 0.015

Ordering Information:

Example: RPA 10 N - dB

Series ———— RPA
Power Rating ———— 10
Substrate Material ———— N: Aluminum Nitride
(No Designation for Beryllium Oxide)
dB Value ———— dB
(See Charts for Available Values)

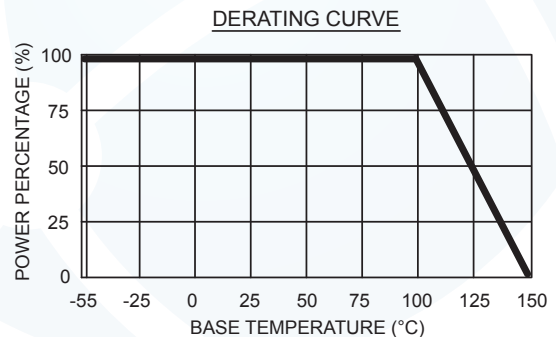

FLANGE ATTENUATORS



General Specifications

Substrate: Beryllium Oxide
 Resistive Film: Thick Film
 Tabs: Silver Plated Beryllium Copper
 Flange: Nickel Plated Copper

Cover: Alumina
 Impedance: 50 Ohms
 Tolerance: $\pm 5\%$
 Operating Temperature:
 -55°C to $+150^{\circ}\text{C}$

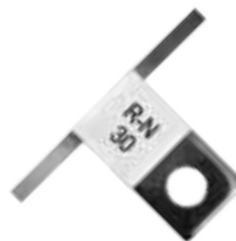

Part Number	Power (W)	Frequency (GHz)	VSWR (max)	Attenuation Accuracy		
				dB	Frequency (GHz)	
RPA20-dB	20	DC-1.0 1.0-2.5	1.15:1 1.35:1		DC-1.0	
					1.0-2.5	
				0-5	± 0.5	± 0.5
				6-9	± 0.5	± 0.5
				10-15	± 0.5	± 1.0
				16-20	± 0.5	± 1.0
	21-30	± 1.0	± 1.0			

RPA20-dB

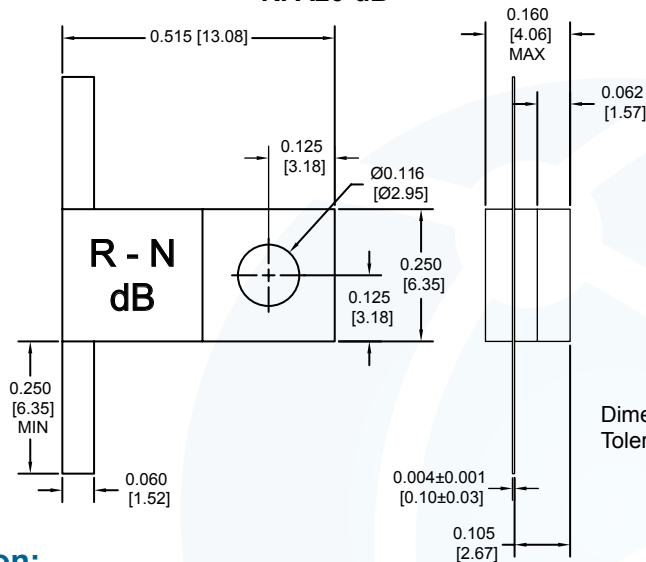

Dimensions are in inches [mm],
 Tolerance: .XXX = ± 0.010 , .XX = ± 0.015

Ordering Information:

Example: RPA 20 N - dB

Series ———— ↑
 Power Rating ———— ↑
 Substrate Material
 N: Aluminum Nitride ———— ↑
 (No Designation for Beryllium Oxide)
 dB Value ———— ↑
 (See Charts for Available Values)

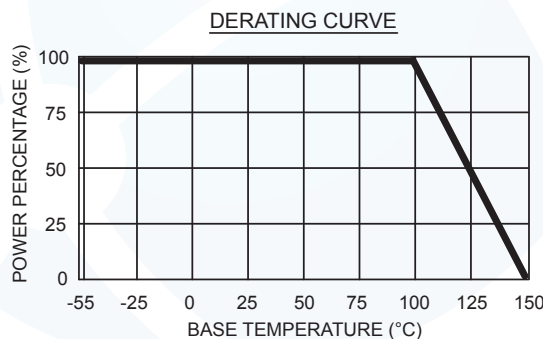

FLANGE ATTENUATORS

General Specifications

Substrate: Beryllium Oxide
Resistive Film: Thick Film
Tab: Silver Plated Beryllium Copper
Flange: Nickel Plated Copper

Cover: Alumina
Impedance: 50 Ohms
Tolerance: $\pm 5\%$
Operating Temperature:
 -55°C to $+150^{\circ}\text{C}$

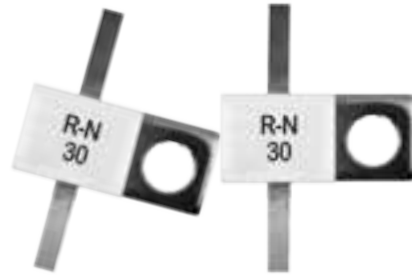

Part Number	Power (W)	Frequency (GHz)	VSWR (max)	Attenuation Accuracy		
				dB	Frequency (GHz)	
RPA25-dB	25	DC-1.0 1.0-2.5	1.15:1 1.25:1			
					DC-1.0	1.0-2.5
				0-5	± 0.3	± 0.5
				6-9	± 0.3	± 0.5
				10-15	± 0.3	± 0.5
				16-20	± 1.0	± 1.0
21-30	± 1.0	± 3.0				

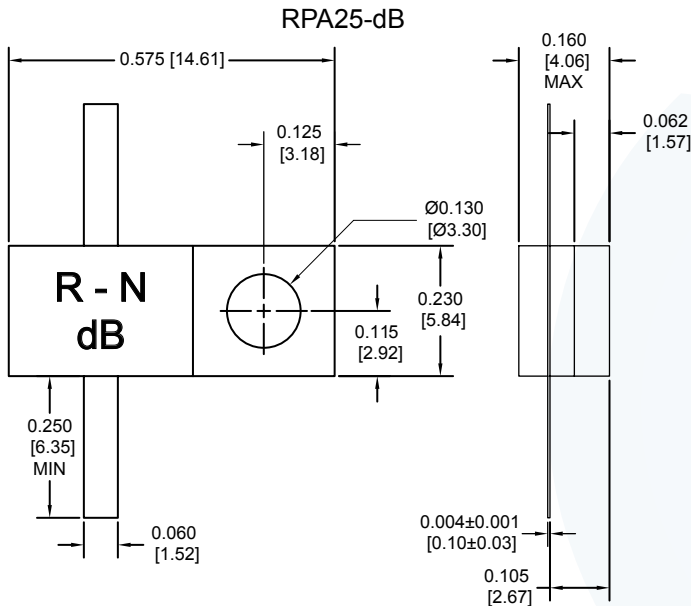

Dimensions are in inches [mm],
Tolerance: .XXX = ± 0.010 , .XX = ± 0.015

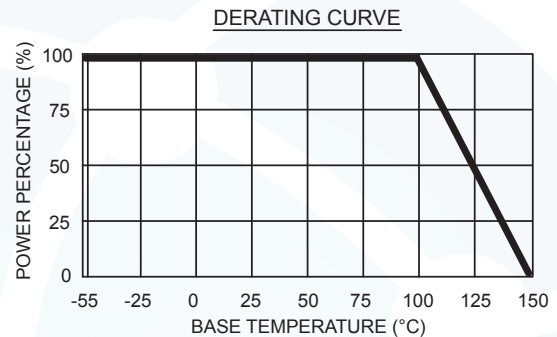

Ordering Information:

Example: RPA 25 N - dB

Series \rightarrow RPA
Power Rating \rightarrow 25
Substrate Material \rightarrow N (Aluminum Nitride)
dB Value \rightarrow dB
(No Designation for Beryllium Oxide)
(See Charts for Available Values)

FLANGE ATTENUATORS



General Specifications

Substrate: Beryllium Oxide
 Resistive Film: Thick Film
 Tab: Silver Plated Beryllium Copper
 Flange: Nickel Plated Copper

Cover: Alumina
 Impedance: 50 Ohms
 Tolerance: $\pm 5\%$
 Operating Temperature:
 -55°C to $+150^{\circ}\text{C}$

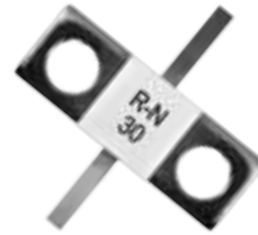

Part Number	Power (W)	Frequency (GHz)	VSWR (max)	Attenuation Accuracy		
RPA35-dB	35	DC-1.0 1.0-2.5	1.15:1 1.25:1	dB	Frequency (GHz)	
					DC-1.0	1.0-2.5
				0-5	± 0.3	± 0.5
				6-9	± 0.3	± 0.5
				10-15	± 0.3	± 0.5
				16-20	± 0.5	± 0.5
21-30	± 1.0	± 3.0				

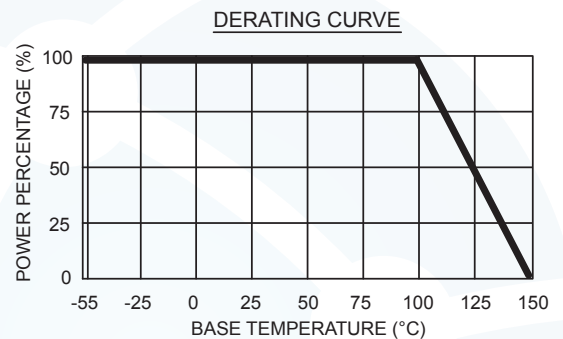
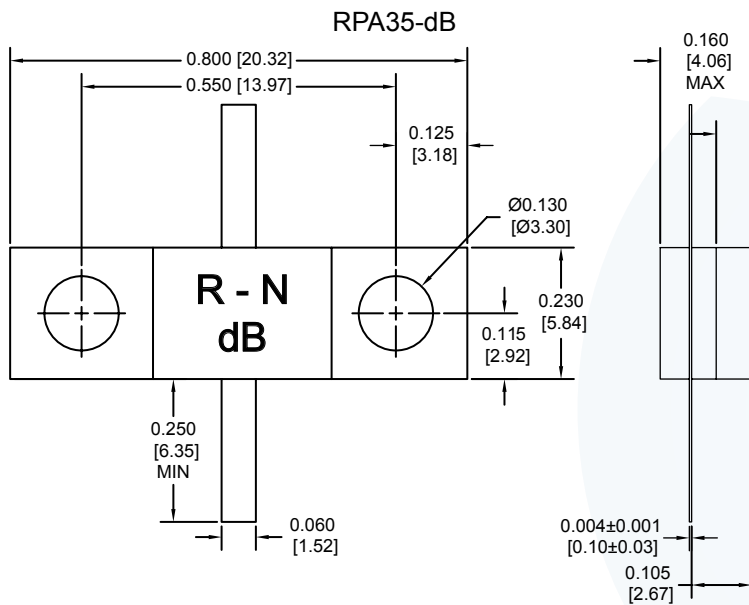

Ordering Information:

Example: RPA 35 N - dB

Series — RPA
 Power Rating — 35
 Substrate Material — N: Aluminum Nitride
 (No Designation for Beryllium Oxide)
 dB Value — dB
 (See Charts for Available Values)



FLANGE ATTENUATORS

General Specifications

Substrate: Beryllium Oxide
Resistive Film: Thick Film
Tab: Silver Plated Beryllium Copper
Flange: Nickel Plated Copper

Cover: Alumina
Impedance: 50 Ohms
Tolerance: $\pm 5\%$
Operating Temperature:
-55°C to +150°C



Part Number	Power (W)	Attenuation (dB)	Frequency (GHz)	VSWR (max)	Attenuation Accuracy (dB)
RPA50-dB	50	1-30	DC-1.0 1.0-2.0	1.15:1 1.25:1	± 0.3 ± 0.5
RPA100-dB	100	1-30	DC-1.0 1.0-2.0	1.15:1 1.25:1	± 0.3 ± 0.5

RPA50-dB

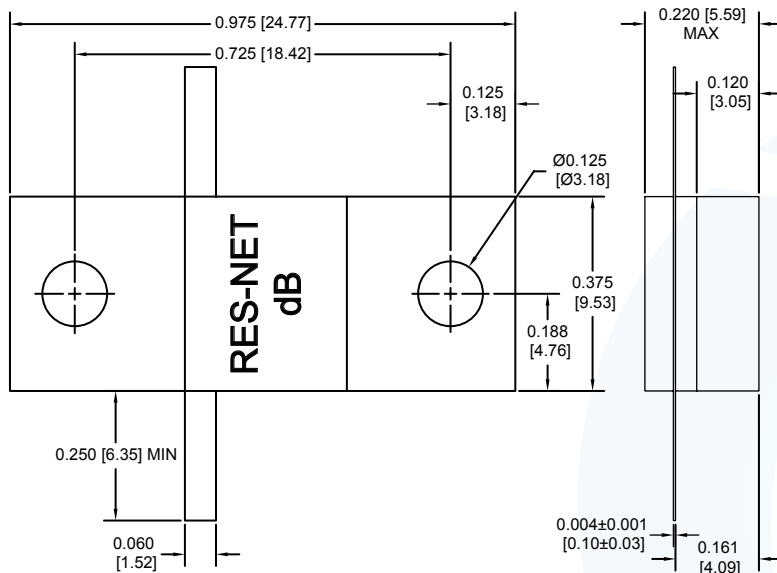

Dimensions are in inches [mm],
Tolerance: .XXX = ± 0.010 , .XX = ± 0.015

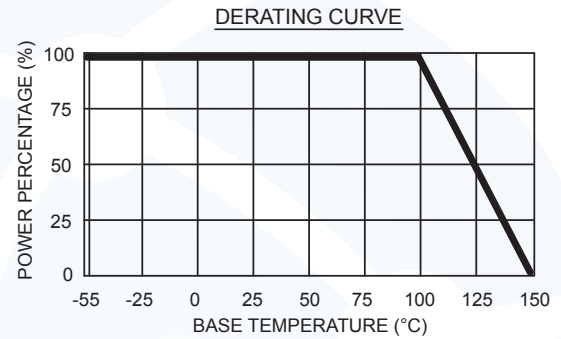

Ordering Information:

Example:

RPA **100** **N** **- dB**
 ↑ ↑ ↑ ↑
 Series Power Rating Substrate Material
 N: Aluminum Nitride
 (No Designation for Beryllium Oxide)
 dB Value
 (See Charts for Available Values)

FLANGE ATTENUATORS



General Specifications

Substrate: Beryllium Oxide
 Resistive Film: Thick Film
 Tab: Silver Plated Beryllium Copper
 Flange: Nickel Plated Copper

Cover: Alumina
 Impedance: 50 Ohms
 Tolerance: $\pm 5\%$
 Operating Temperature:
 -55°C to +150°C

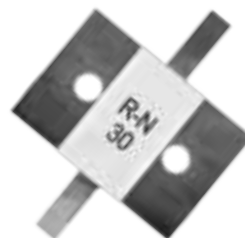

Part Number	Power (W)	Frequency (GHz)	VSWR (max)	Attenuation Accuracy			
				dB	Frequency (GHz)		
RPA125-dB	125	DC-1.0 1.0-2.0 2.0-3.0	1.15:1 1.20:1 1.25:1		DC-1.0	1.0-2.5	2.0-3.0
				0-10	± 0.3	± 0.4	± 0.6
				11-20	± 0.4	± 0.6	± 0.75
				31-30	± 0.5	± 0.75	

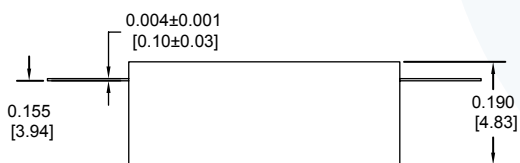
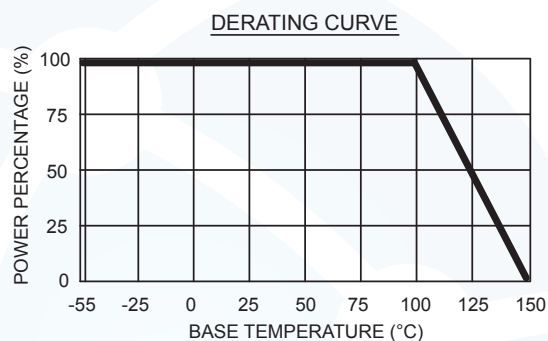
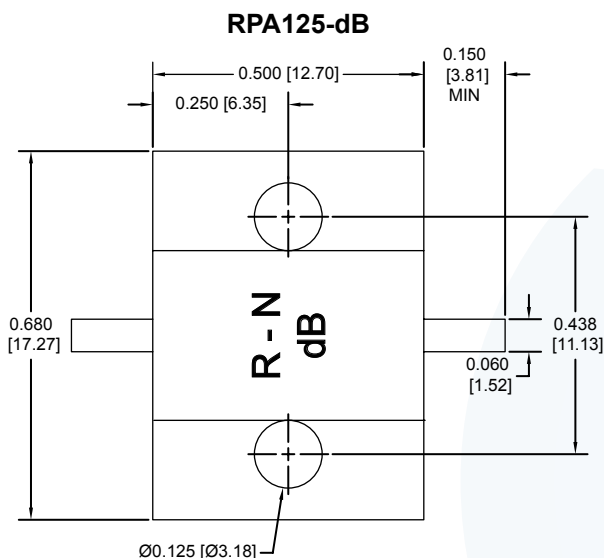

Dimensions are in inches [mm],
 Tolerance: .XXX = ± 0.010 , .XX = ± 0.015

Ordering Information:

Example:

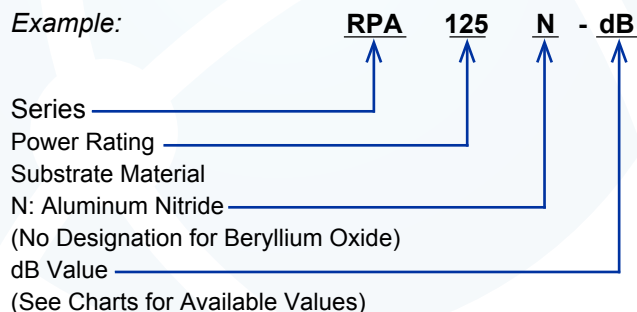

General Specifications

Substrate: Beryllium Oxide
Resistive Film: Thick Film
Tab: Silver Plated Beryllium Copper
Flange: Nickel Plated Copper

Cover: Alumina
Impedance: 50 Ohms
Tolerance: $\pm 5\%$
Operating Temperature:
 -55°C to $+150^{\circ}\text{C}$

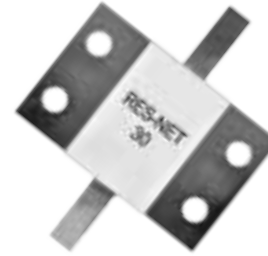

Part Number	Power (W)	Frequency (GHz)	VSWR (max)	Attenuation Accuracy	
				dB	Frequency (GHz)
RPA200-dB	200	DC-1.0 GHz	1.15:1		DC-0.5
					1.0-2.5
RPA250-dB	250	DC-1.0 GHz	1.15:1	0-10	± 0.23
				11-20	± 0.3
				21-30	± 1.0

RPA200 & RPA250

RPA200 & RPA250

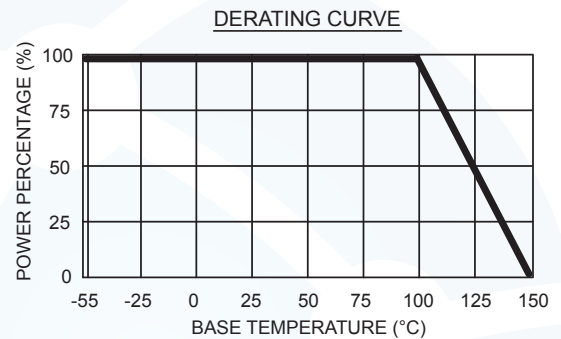
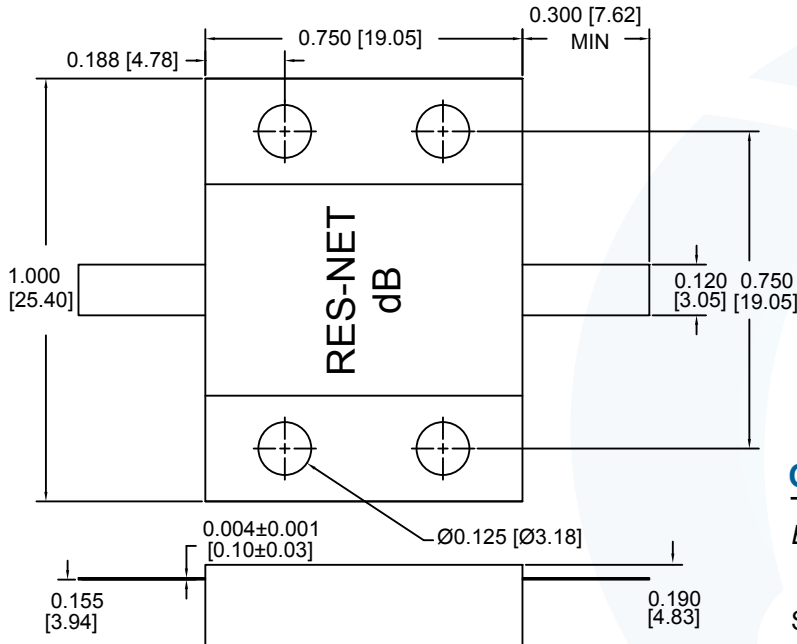

Ordering Information:

Example:

RPA **250** **N** **- dB**
 ↑ ↑ ↑ ↑
 Series Power Rating Substrate Material dB Value
 N: Aluminum Nitride
 (No Designation for Beryllium Oxide)
 (See Charts for Available Values)

COAXIAL ATTENUATORS RA2 & RA5 CONDUCTION COOLED SMA TYPE CONNECTORS



General Specifications

Impedance: 50 Ohms
 Mechanical Tolerance: 0.010 inch unless otherwise specified
 Temperature Coefficient: 100 PPM/°C maximum from -55°C to +100°C
 Temperature Range: -55°C to +150°C
 Connectors: Passivated Stainless Steel



Part Number	Frequency (GHz)	VSWR (max)	Power (W)
RA2-2	DC-2.0	1.10:1	2
RA2-4	DC-4.0	1.15:1	2
RA2-8	DC-8.0	1.20:1	2
RA2-12	DC-12.0	1.25:1	2
RA2-18	DC-18.0	1.35:1	2
RA5-2	DC-2.0	1.10:1	5
RA5-4	DC-4.0	1.15:1	5
RA5-8	DC-8.0	1.20:1	5
RA5-12	DC-12.0	1.25:1	5
RA5-18	DC-18.0	1.35:1	5

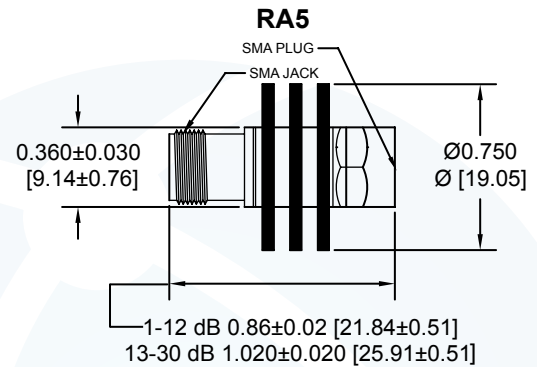
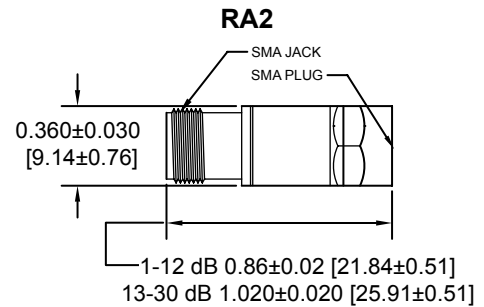

Attenuation Accuracy: 1-6dB (± 0.30); 7-20 (± 0.50);
 21-30 (± 0.75)

Dimensions are in inches [mm],
 Tolerance: .XXX = ±0.010, .XX = ±0.015

Ordering Information:

Example: RA 2 -18 S FM dB

Series → RA
 Power (W) → 2
 MAX Frequency (GHz) → -18
 Connector Type → S
 S: SMA
 K: 2.92mm
 N: N-Type
 Connector Female-Male → FM
 Attenuation → dB
 (See Tables For Available Values)

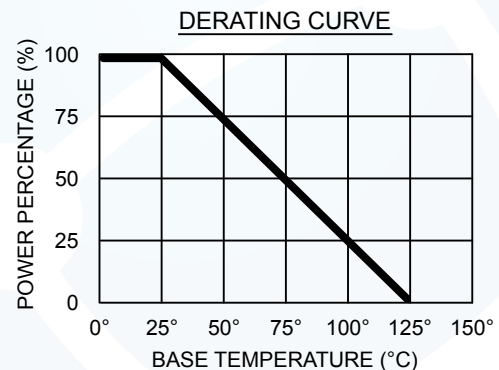

COAXIAL ATTENUATORS

RA2 CONDUCTION COOLED

"2.92mm" TYPE CONNECTORS

General Specifications

Impedance: 50 Ohms
 Mechanical Tolerance: ± 0.010 inch unless otherwise specified
 Temperature Coefficient: ± 100 PPM/ $^{\circ}\text{C}$ maximum from -55°C to $+100^{\circ}\text{C}$
 Temperature Range: -55°C to $+150^{\circ}\text{C}$
 Housing: Nickel Plated Brass
 Connectors: Passivated Stainless Steel



Part Number	Frequency (GHz)	VSWR (max)	Power (W)	Attenuation Accuracy (dB)		
				0-6, 8	10, 15, 20	30
RA2-40	DC-26.5 26.5-40	1.40:1	2	± 0.5 ± 0.8	± 0.5 ± 1.0	± 0.8 ± 1.0

RA2-40

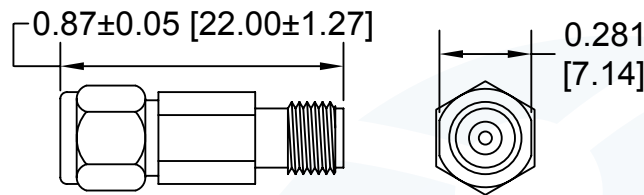

Dimensions are in inches [mm],
 Tolerance: .XXX = ± 0.010 , .XX = ± 0.015

Ordering Information:

Example:

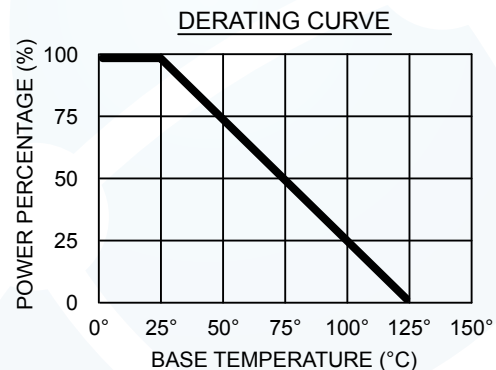
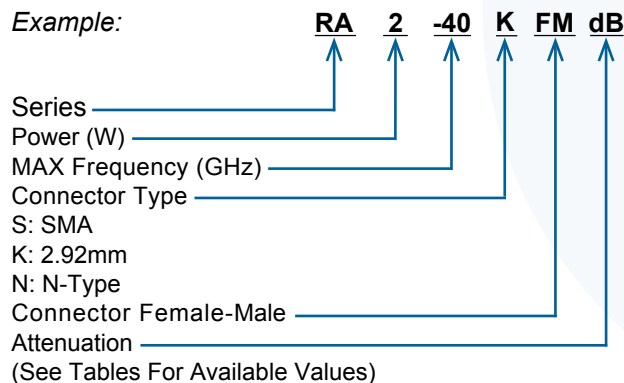

COAXIAL ATTENUATORS

RA10 & RA20

CONDUCTION COOLED N-TYPE CONNECTORS



General Specifications

Impedance: 50 Ohms
 Mechanical Tolerance: ± 0.010 inch unless otherwise specified
 Temperature Coefficient: ± 100 PPM/ $^{\circ}\text{C}$ maximum from -55°C to $+100^{\circ}\text{C}$
 Temperature Range: -55°C to $+150^{\circ}\text{C}$
 Housing: Nickel Plated Brass
 Connectors: Passivated Stainless Steel



Part Number	Frequency (GHz)	VSWR (max)	Power (W)	Attenuation Accuracy (dB)		
				1-6	7-20	21-30
RA10-2	DC-2.0 GHz	1.15:1	10	± 0.30	± 0.50	± 0.75
RA10-4	DC-4.0 GHz	1.25:1	10			
RA10-8	DC-6.0 GHz	1.35:1	10			
RA20-2	DC-2.0 GHz	1.15:1	20			
RA20-4	DC-4.0 GHz	1.25:1	20			
RA20-6	DC-6.0 GHz	1.35:1	20			

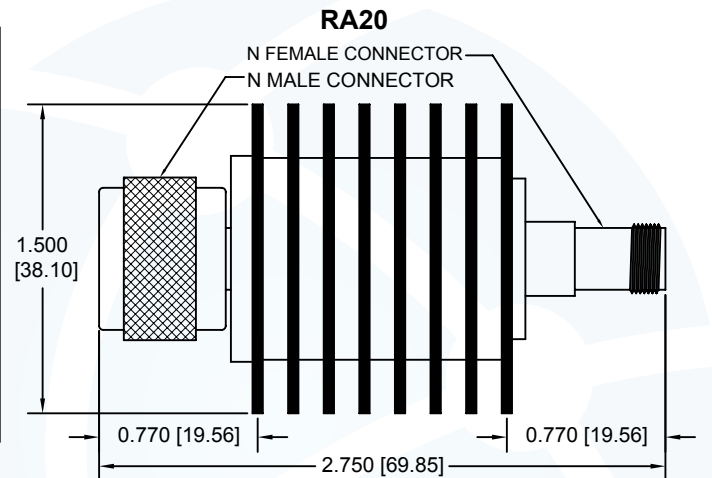
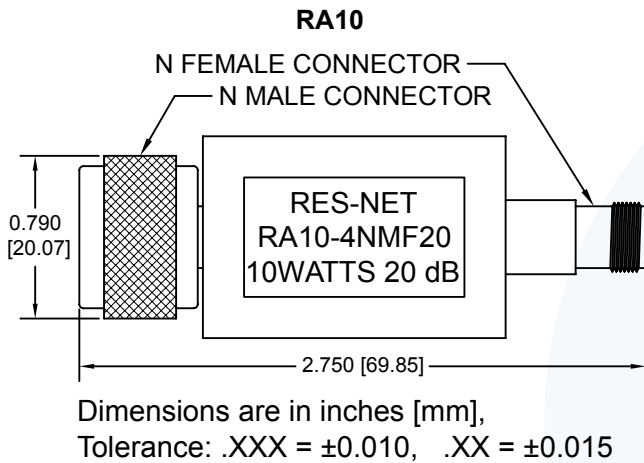

Ordering Information:

Example: RA 20 -6 N FM dB

Series — RA
 Power (W) — 20
 MAX Frequency (GHz) — -6
 Connector Type — N
 S: SMA
 T: TNC
 N: N-Type
 Connector Female-Male — FM
 Attenuation — dB
 (See Tables For Available Values)

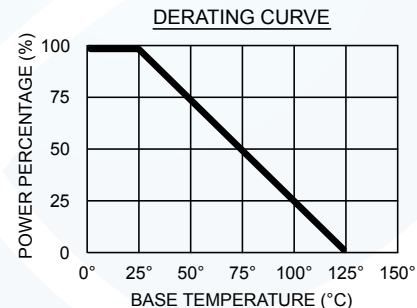

General Specifications

Housing: Nickel Plated Aluminum or Copper

Resistive Material: Thick Film

Connectors: SMA, Type N or TNC



Part Number	Impedance	Attenuation Accuracy (dB)	Frequency GHz	VSWR (max)	Temperature Range	Power (W)
RPAX25-XXXdB	50 Ohms	±0.3	DC-2.0	1.15:1	-55° to +150°C	25

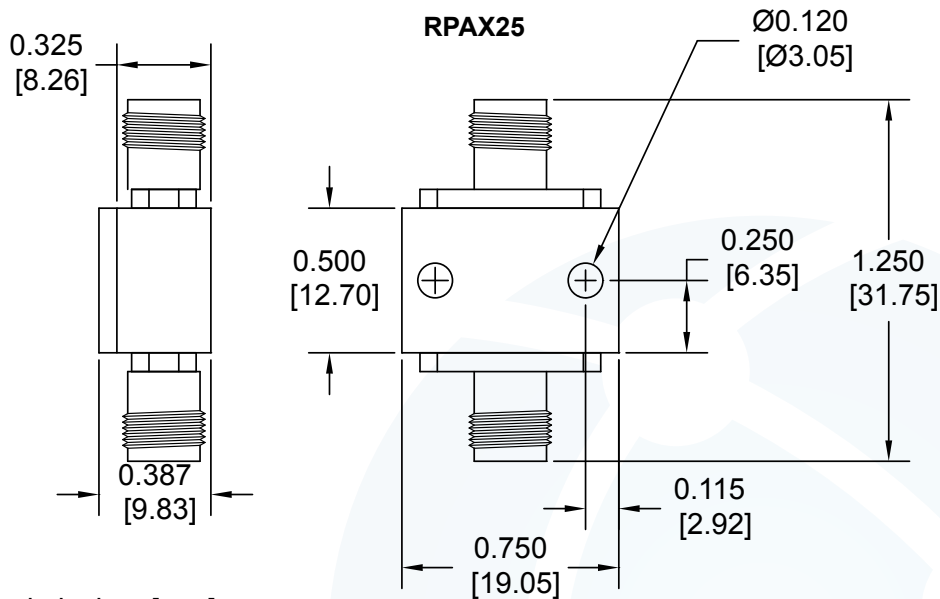

Dimensions are in inches [mm],
Tolerance: .XXX = ±0.010, .XX = ±0.015

Ordering Information:

Example: **RPAX 25 -S MF dB**

Series ———— ↑
Power Rating (W) ———— ↑
Connector Type ———— ↑
S: SMA
N: N-Type
T: TNC
Gender ———— ↑
M: Male
F: Female
dB Value ———— ↑
(See Tables For Available Values)

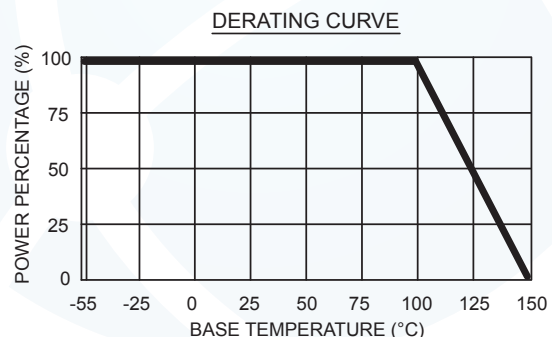

COAXIAL ATTENUATORS

CONDUCTION COOLED

RPAX50 & RPAX100



General Specifications

Housing: Nickel Plated Aluminum or Copper

Resistive Material: Thick Film

Connected: Passivated SMA Female (Type N and TNC also available)



Part Number	Impedance	Attenuation Accuracy (dB)	Frequency (GHz)	VSWR (max)	Temperature (°C)	Power (W)
RPAX50-XXXdB	50 Ohms	±0.5 (0 – 10) ±1.0 (20, 30, 40)	DC-3.0	1.35:1	-55 to +150	50
RPAX100-XXXdB	50 Ohms	±0.5 (0 – 10) ±1.0 (20, 30, 40)	DC-3.0	1.35:1	-55 to +150	100

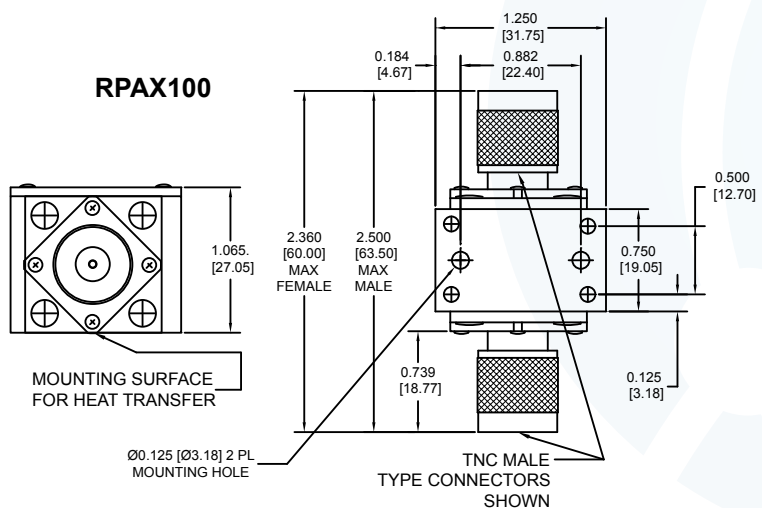
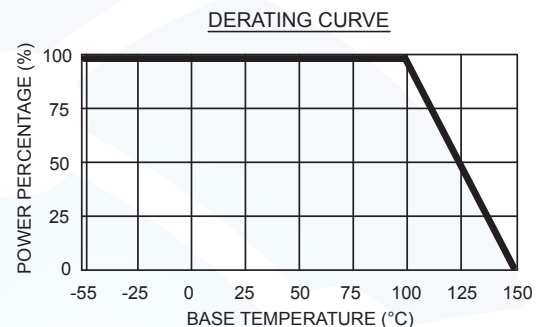
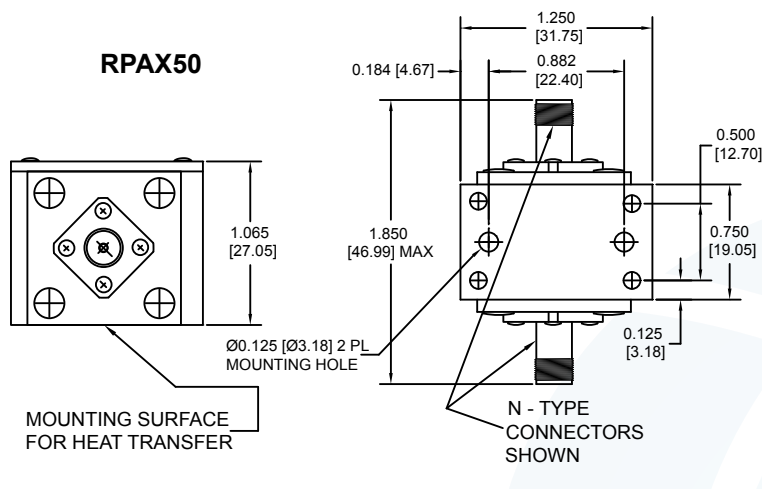

Ordering Information:

Example: **RPAX 100 -S MF dB**

Series —————→ RPAX
 Power Rating (W) —————→ 100
 Connector Type —————→ -S
 Gender —————→ MF
 dB Value —————→ dB

S: SMA
 N: N-Type
 T: TNC
 M: Male
 F: Female
 (See Tables For Available Values)



COAXIAL ATTENUATORS

CONDUCTION COOLED

RPAX250

General Specifications

Housing: Nickel Plated Copper
 Resistive Material: Thick Film
 Connected: Passivated SMA Female
 (Type N and TNC also available)
 Impedance: 50 Ohms



Part Number	Attenuation (dB)	Attenuation Accuracy (dB)		VSWR (max)		Power (W)
		DC – 1.0 GHz	1.0 - 2.4 GHz	DC – 1.0 GHz	1.0 – 2.4 GHz	
RPAX250-XXXdB	0.5 – 3 3 – 10 10 – 40	±0.3 ±0.5 ±0.5	±0.75 ±1.0 ±1.5	1.15:1	1.25:1	250

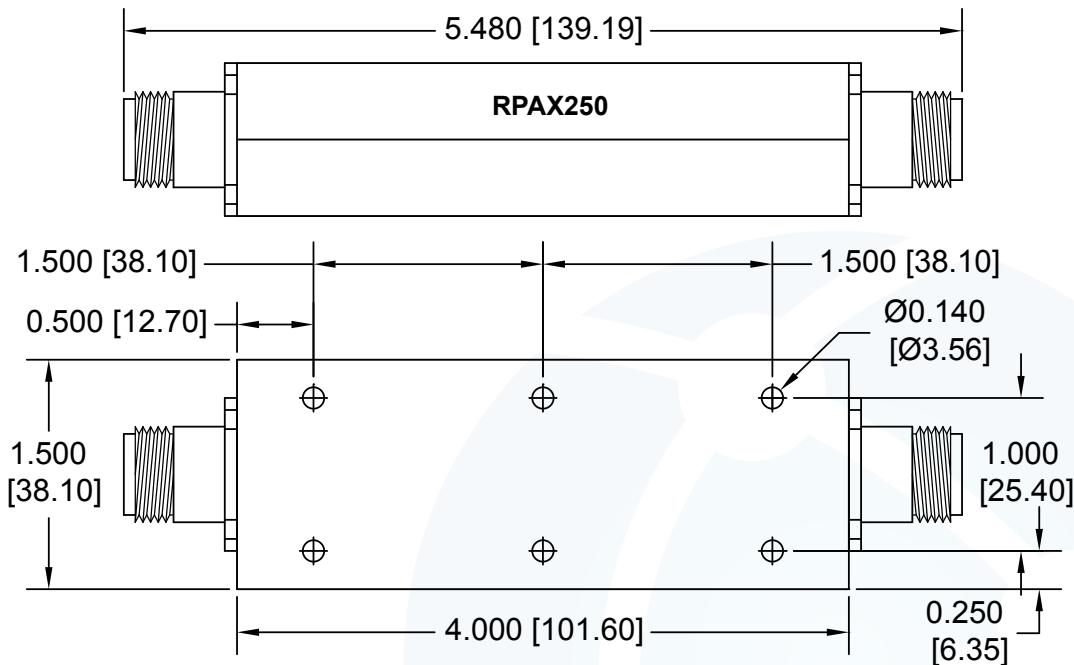

Dimensions are in inches [mm], Tolerance: .XXX = ±0.010, .XX = ±0.015

Ordering Information:

Example: **RPAX 250 -S MF dB**

Series —————→ RPAX
 Power Rating (W) —————→ 250
 Connector Type —————→ -S
 Gender —————→ MF
 dB Value —————→ dB

S: SMA
 N: N-Type
 T: TNC
 M: Male
 F: Female
 dB Value (See Tables For Available Values)

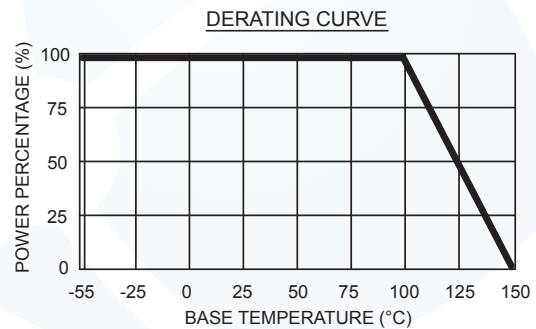

COAXIAL ATTENUATORS CONDUCTION COOLED RPAX500



General Specifications

Housing: Nickel Plated Copper
Resistive Material: Thick Film
Connected: Passivated SMA Female
(Type N and TNC also available)
Impedance: 50 Ohm

Part Number	Attenuation (dB)	Attenuation Accuracy (dB)		VSWR (max)		Power (W)
		DC - 1.0 GHz	1.0 - 2.4 GHz	DC - 1.0 GHz	1.0 - 2.4 GHz	
RPAX500-XXXdB	0.5 - 3 3 - 10 10 - 40	±0.3 ±0.5 ±0.5	±0.75 ±1.0 ±1.5	1.10:1	1.25:1	500

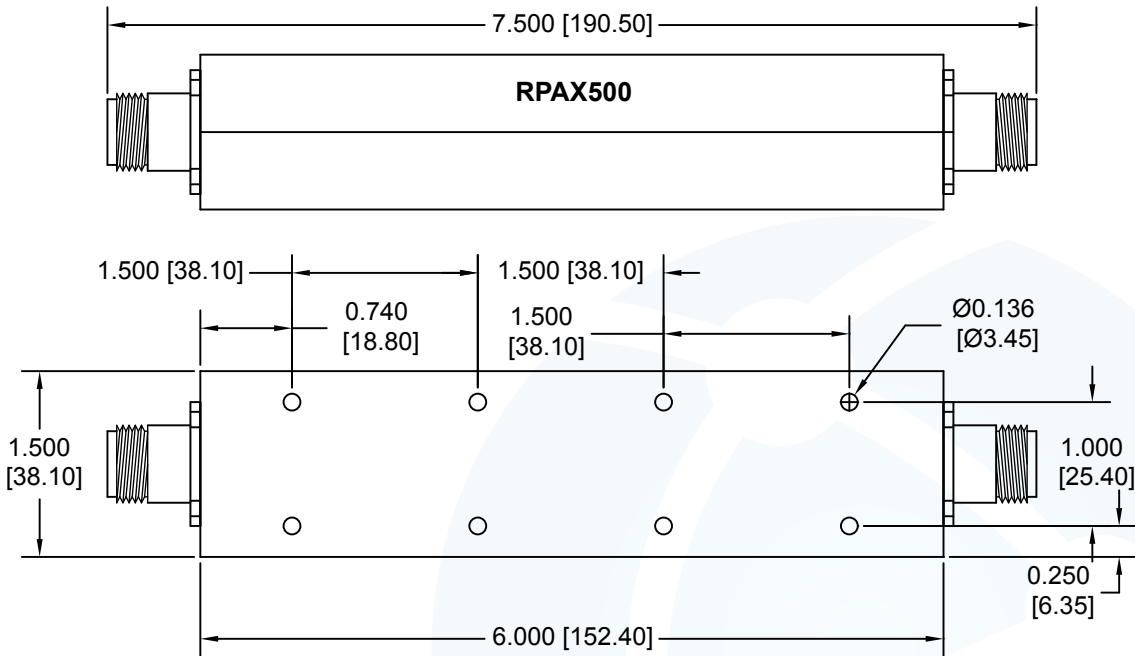

Dimensions are in inches [mm], Tolerance: .XXX = ±0.010, .XX = ±0.015

Ordering Information:

Example: **RPAX 500 -S MF dB**

Series ————— RPAX
Power Rating (W) ————— 500
Connector Type ————— -S
Gender ————— MF
dB Value ————— dB
(See Tables For Available Values)

S: SMA
N: N-Type
T: TNC
M: Male
F: Female

DERATING CURVE

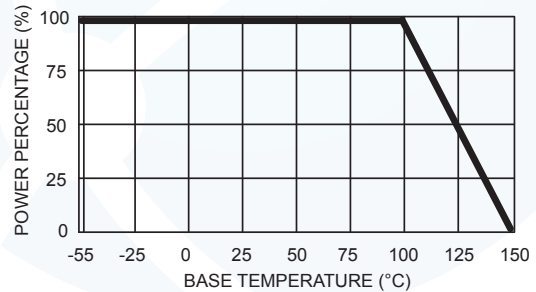

COAXIAL ATTENUATORS

CONVECTION COOLED

N-TYPE RA SERIES

General Specifications

Connectors: N-Type Brass Nickel Plated
 Pins: Gold Plated Brass (Male); Gold Plated Beryllium Copper (Female)
 Housing: Black Anodized Aluminum
 Impedance: 50 Ohms
 Power rating 10W
 Temperature Range: -55°C to +125°C



Part Number	Attenuation Accuracy (dB)					Frequency (GHz)	VSWR (max)
	1-9	10	20	30	40		
RA010-2NMF-dB	±0.4	±0.4	±0.4	±0.5	±0.5	DC-2.0	1.15:1
RA010-3NMF-dB	±0.4	±0.5	±0.6	±0.6	±0.8	DC-3.0	1.20:1
RA010-4NMF-dB	±0.5	±0.6	±0.6	±0.6	±0.8	DC-4.0	1.20:1
RA010-6NMF-dB	±0.5	±0.6	±0.6	±0.6	±0.8	DC-6.0	1.25:1

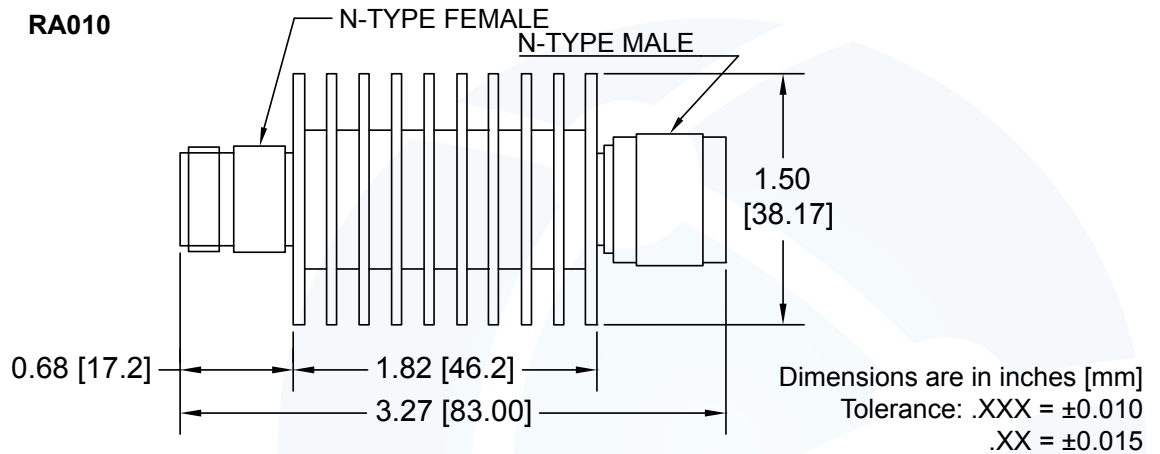

Ordering Information:

Example: **RA0 10 -4 NMF -dB**

Series **RA0**
 Power (W) **10**
 MAX Frequency (GHz) **-4**
 12 = 12.4
 26 = 26.5
 N: N-Type
 S: SMA
 Male & Female Connectors
 See Tables For Available Values

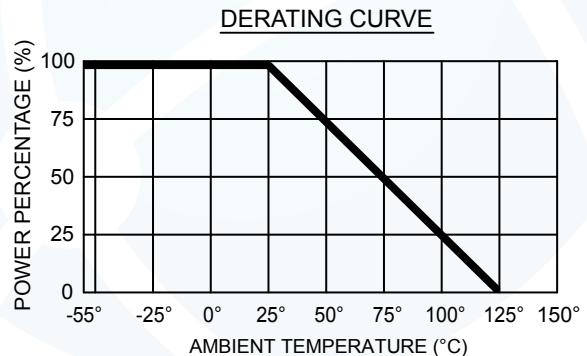

COAXIAL ATTENUATORS CONVECTION COOLED N-TYPE RA SERIES



General Specifications

Connectors: N-Type Brass Nickel Plated
 Pins: Gold Plated Brass (Male); Gold Plated Beryllium Copper (Female)
 Housing: Black Anodized Aluminum
 Impedance: 50 Ohms
 Power rating 25W
 Temperature Range: -55°C to +125°C



Part Number	Attenuation Accuracy (dB)						Frequency (GHz)	VSWR (max)
	1-9	10	20	30	40	50		
RA025-2NMF-dB	±0.4	±0.4	±0.5	±0.5	±0.75	±1.0	DC-2.0 GHz	1.15:1
RA025-3NMF-dB	±0.4	±0.5	±0.6	±0.6	±1.0	±1.2	DC-3.0 GHz	1.20:1
RA025-4NMF-dB	±0.5	±0.6	±0.6	±0.6	±1.0	±1.5	DC-4.0 GHz	1.25:1
RA025-6NMF-dB	±0.5	±0.6	±0.75	±0.75	±1.0	±1.5	DC-6.0 GHz	1.25:1

RA025

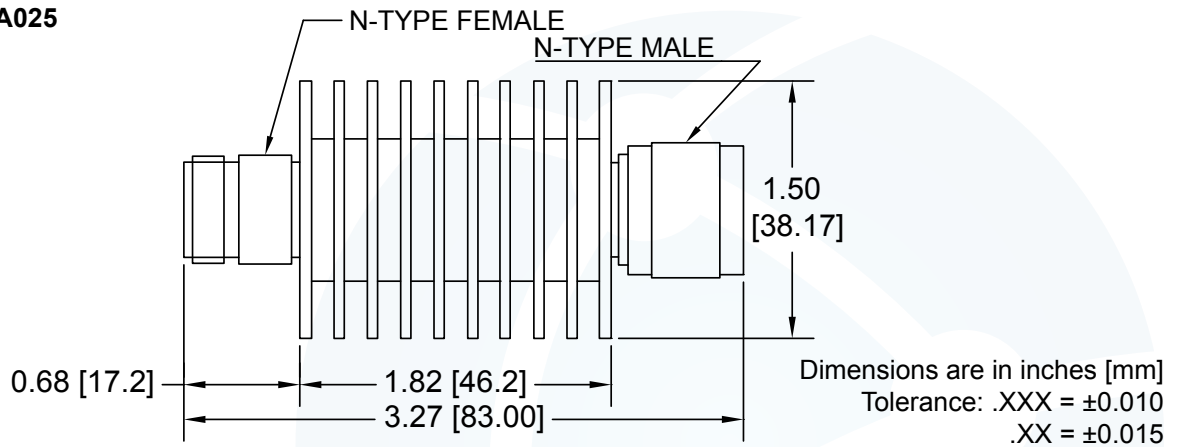

Ordering Information:

Example: **RA0 25 -4 NMF -dB**

Series **RA0**
 Power (W) **25**
 MAX Frequency (GHz) **-4**
 12 = 12.4
 26 = 26.5
 N: N-Type
 S: SMA
 Male & Female Connectors
 See Tables For Available Values

DERATING CURVE

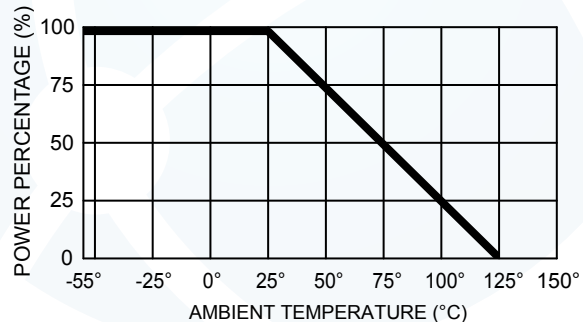

COAXIAL ATTENUATORS

CONVECTION COOLED

N-TYPE RA SERIES

General Specifications

Connectors: N-Type Brass Nickel Plated
 Pins: Gold Plated Brass (Male); Gold Plated Beryllium Copper (Female)
 Housing: Black Anodized Aluminum
 Impedance: 50 Ohms
 Power rating 50W
 Temperature Range: -55°C to +125°C



Part Number	Attenuation Accuracy (dB)						Frequency (GHz)	VSWR (max)
	10	20	30	40	50	60		
RA050-8NMF	±0.4	±0.6	±0.5	±0.8	-1.0/+0.5	-1.0/+0.5	DC-8.0	1.20:1
RA050-12NMF	±0.5	±0.6	±0.8	±1.0	-1.0/+0.75	-1.0/+0.75	DC-12.4	1.25:1
RA050-18NMF	±1.0	±1.0	±1.0	-1.0/+1.5	±1.0	±1.0	DC-18.0	1.30:1

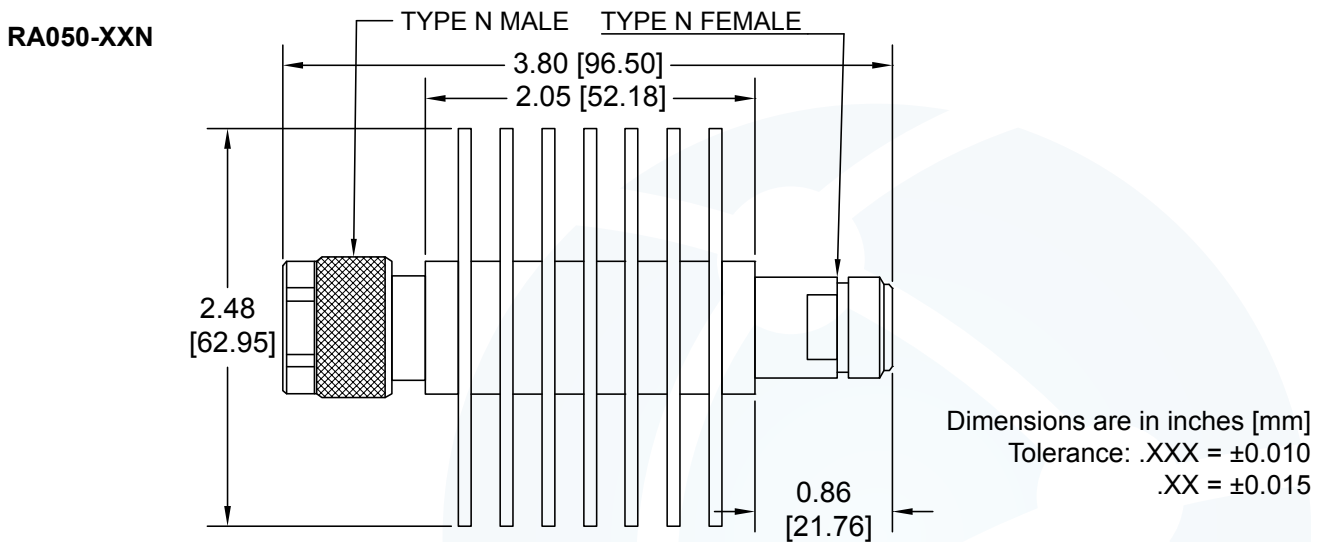

Ordering Information:

Example: **RA0 50 -4 NMF -dB**

Series **RA0**

Power (W) **50**

MAX Frequency (GHz) **-4**

12 = 12.4

26 = 26.5

N: N-Type

S: SMA

Male & Female Connectors

See Tables For Available Values

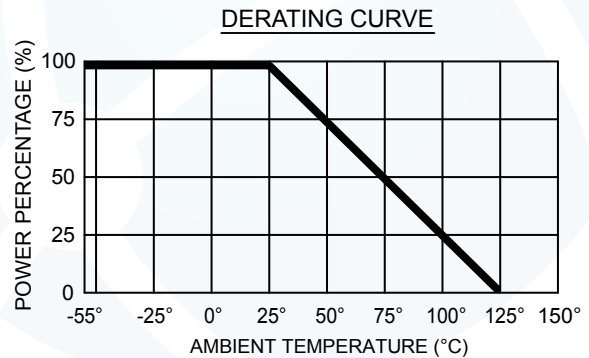

COAXIAL ATTENUATORS

CONVECTION COOLED

SMA TYPE RA SERIES



General Specifications

Connectors: SMA Brass Nickel Plated
 Pins: Gold Plated Brass (Male); Gold Plated Beryllium Copper (Female)
 Housing: Black Anodized Aluminum
 Impedance: 50 Ohms
 Power rating 50W
 Temperature Range: -55°C to +125°C



Part Number	Attenuation Accuracy (dB)						Frequency (GHz)	VSWR (max)
	10	20	30	40	50	60		
RA050-12SMF	±0.5	±0.5	±0.8	±0.8	-1.0/+0.7	-1.0/+0.5	DC-12.4	1.25:1
RA050-18SMF	±1.0	±1.0	±1.0	±1.0	±1.0	-1.0/+0.75	DC-18.0	1.30:1
RA050-26SMF	-1.0/+2.5	-1.0/+1.5	-1.0/+1.5	-1.0/+1.5	±1.0	±1.0	DC-16.5	1.35:1

RA050-SXX

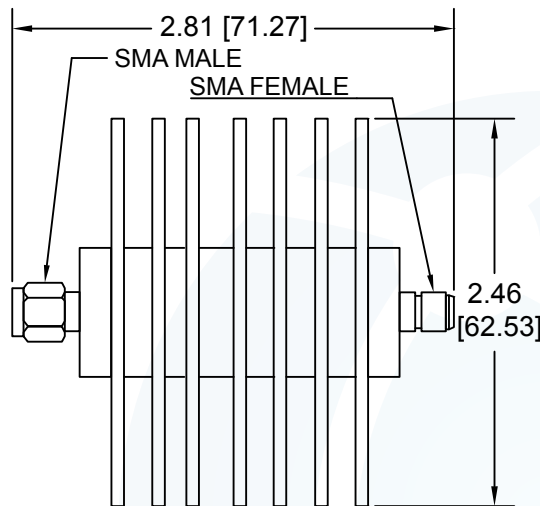

Dimensions are in inches [mm]
 Tolerance: .XXX = ±0.010
 .XX = ±0.015

Ordering Information:

Example: **RA0 50 -26 SMF -dB**

Series ↑
 Power (W) ↑
 MAX Frequency (GHz) ↑
 12 = 12.4
 26 = 26.5
 N: N-Type ↑
 S: SMA
 Male & Female Connectors
 See Tables For Available Values

DERATING CURVE

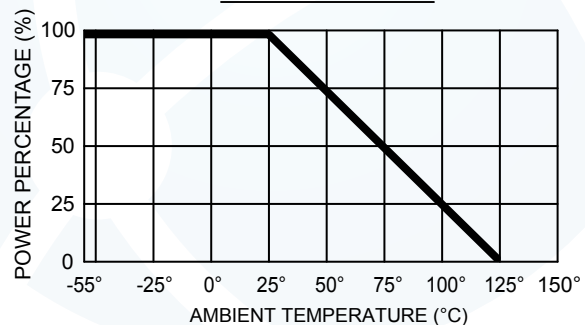

COAXIAL ATTENUATORS CONVECTION COOLED



General Specifications

Substrate: Beryllium Oxide
Resistive Material: Thick Film
Connector Body: N-Type, other connectors available upon request
Connector Interface: Conforms to MIL-C-39012

Housing: Black Anodized Aluminum
Heat Spreader: Copper
Impedance: 50 Ohms
Frequency: DC - 3 GHz

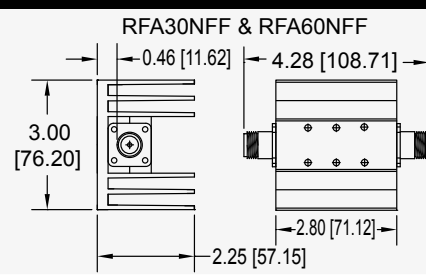
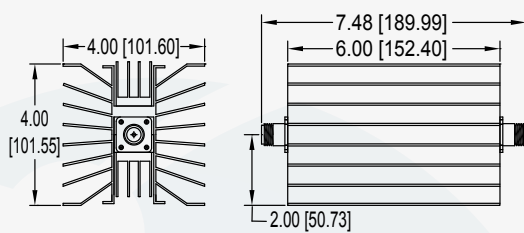
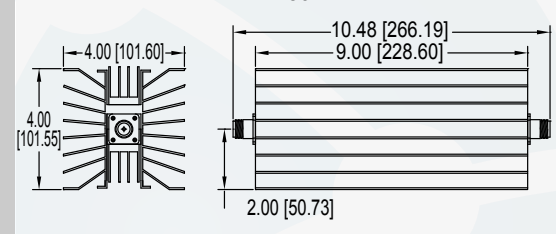
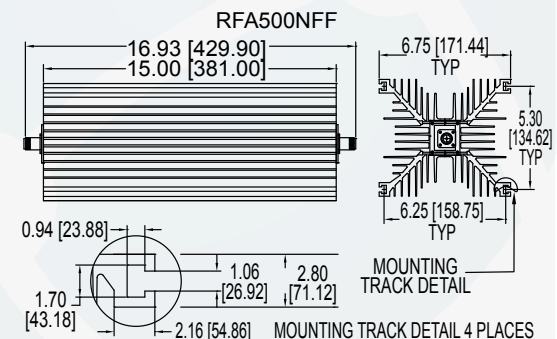
Part Number	Power (W)	Attenuation (dB)	Attenuation Accuracy (dB)	Frequency (GHz)	VSWR (max)	Mechanical Outline
RFA30NFFdB	30	1 - 20 30	±0.5 ±1.0	DC-1.0 1.0 - 3.0	1.15:1 1.35:1	RFA30NFF & RFA60NFF 
RFA60NFFdB	60	1 - 20 30	±0.5 ±1.0	DC-1.0 1.0 - 3.0	1.15:1 1.35:1	
RFA100NFFdB	100	1 - 20 30	±0.5 ±1.0	DC-1.0 1.0 - 3.0	1.15:1 1.35:1	RFA100NFF & RFA150NFF 
RFA150NFFdB	250	1 - 20 30	±0.5 ±1.0	DC-1.0 1.0 - 3.0	1.15:1 1.35:1	
RFA250NFFdB	250	1 - 20 30	±0.5 ±1.0	DC-1.0 1.0 - 3.0	1.25:1 1.35:1	RFA250NFF 
RFA500NFFdB	500	1 - 20 30	±0.5 ±1.0	DC-1.0 1.0 - 3.0	1.25:1 1.35:1	RFA500NFF 

Dimensions are in inches [mm], Tolerance: .XXX = ±0.010, .XX = ±0.015

COAXIAL ATTENUATORS CONVECTION COOLED



General Specifications

Substrate: Beryllium Oxide
Resistive Material: Thick Film
Connector Body: N-Type, other connectors available upon request

Housing: Black Anodized Aluminum
Heat Spreader: Copper
Impedance: 50 Ohms
Frequency: DC - 3 GHz

Connector Interface: Conforms to MIL-C-39012



Part Number	Power (W)	Attenuation (dB)	Attenuation Accuracy (dB)	Frequency (GHz)	VSWR (max)	Mechanical Outline
RFA1000NFFdB	1000	3 - 20 30	±0.5 ±1.0	DC-1.0 1.0 - 3.0	1.25:1 1.35:1	
RFA1500NFFdB	1500	3 - 30	±0.3	DC-0.5	1.25:1	
RFA2000NFFdB	2000	3 - 30	±0.3	DC - 0.5	1.25:1	

Dimensions are in inches [mm], Tolerance: .XXX = ±0.010, .XX = ±0.015

Ordering Information:

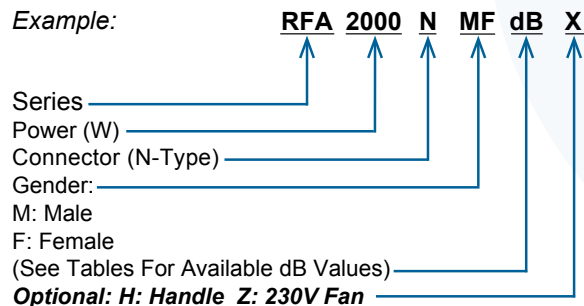

DERATING CURVE

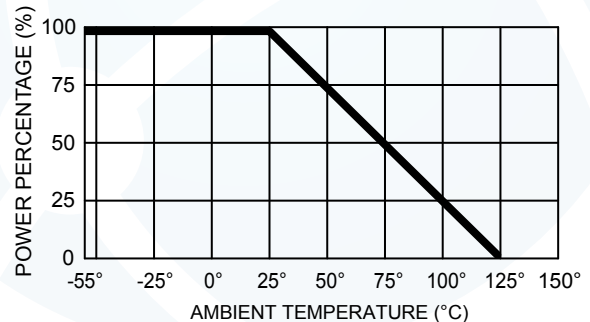

COAXIAL ATTENUATORS CONVECTION COOLED

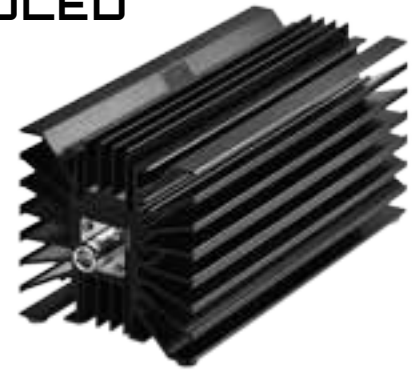

General Specifications

Substrate: Beryllium Oxide
Resistive Material: Thick Film
Connector Body: N-Type, other connectors available upon request
Connector Interface: Conforms to MIL-C-39012

Housing: Black Anodized Aluminum
Heat Spreader: Copper
Impedance: 50 Ohms
Frequency: DC - 6 GHz

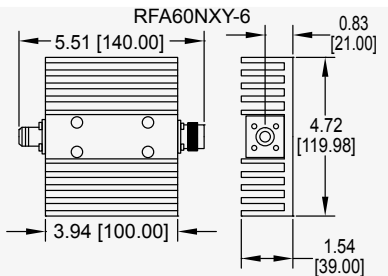
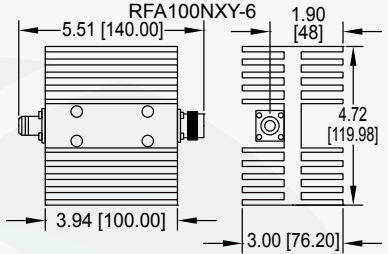
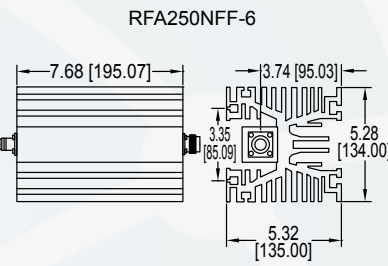
Part Number	Power (W)	Attenuation (dB)	Attenuation Accuracy (dB)	Frequency (GHz)	VSWR (max)	Mechanical Outline
RFA60NXY-dB-6	30	3 6 10 20 30 40	±0.5 ±0.5 ±1.0 ±1.0 ±1.0 ±1.0	DC-3.0 3.0 – 6.0	1.20:1 1.30:1	
RFA100NXY-dB-6	100	3 6 10 20 30 40	±0.5 ±0.5 ±1.0 ±1.0 ±1.0 ±1.5	DC-3.0 3.0 – 6.0	1.20:1 1.30:1	
RFA250NXY-dB-6	250	3 6 10 20 30 40 50	±0.75 ±0.75 ±1.0 ±1.0 ±1.0 ±1.0 ±1.5	DC-3.0 3.0 – 6.0	1.20:1 1.30:1	

Dimensions are in inches [mm]
Tolerance: .XXX = ±0.010
.XX = ±0.015

Ordering Information:

Example: **RFA 250 N MF dB 6**

Series → RFA
Power (W) → 250
Connector (N-Type) → N
Gender: M: Male, F: Female → MF
(See Tables For Available dB Values) → dB
Frequency (GHz) → 6

DERATING CURVE

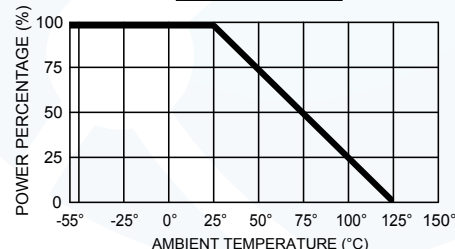

RESISTORS



Resistors are passive electrical components, which resist, or limit current in electrical circuits. These two-terminal components are designed to have a certain amount of resistance. Resistors are used in many applications to divide and lower voltage, or adjust signal levels. In addition, they are used to dissipate large amount electrical power as heat.

Even though resistors come in many different shape and sizes, they can all be placed in two main categories: fixed and variable. Fixed resistors have a fixed resistance value, while variable resistors have a resistance value that can be changed manually or automatically.

Resistors used in RF & Microwave applications require special design considerations regarding parasitic capacitance, series inductance and power dissipation. For example, at low-frequency resistor looks like a resistor. On the other hand, a high frequency resistor will have parasitic capacitance and inductance, which limits the high frequency performance.

Res-Net Microwave, Inc. offers a full line of high power RF resistors including: chip, surface mount, tab & cover, flange mounted, rod, and disk types. Our resistors are designed to minimize parallel capacitance and series inductance for high frequency performance. Standard resistance values range from 0.5 Ohms to 500 Ohms.

Our resistors are capable of handling power up to 1.5kW and frequencies up to 30GHz. For best power and frequency performance, our resistors are made from: Alumina, Beryllium Oxide (BeO), Aluminum Nitrate (AlN), and Chemical Vapor Deposition (CVD) diamond substrate materials.



Features:

- Frequency Range from DC to 40GHz
- Power Handling up to 2000 Watts
- Excellent Attenuation Accuracy
- Alumina, ALN, BeO or CVD Diamond Substrates
- Temperature Range: -55°C to +150°C
- High Reliability Versions Available

Applications:

- High Power Amplifiers
- Broadcast
- Base Stations
- Instrumentation
- Telecom
- Military
- Satellite



General Specifications

Substrate: Beryllium Oxide or Aluminum Nitride
Resistive Film: Thick Film
Terminals: Silver
Reliability: MIL-PRF-55342

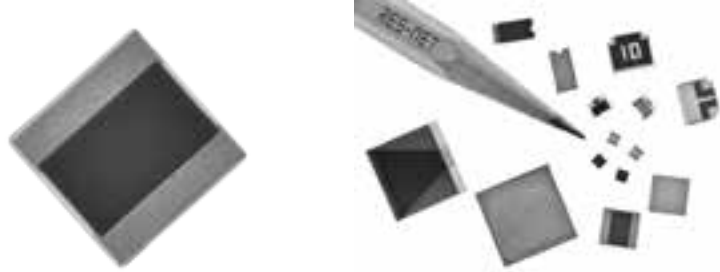

Beryllium Oxide Part Number	W (±0.010)	L (±0.010)	T (±0.005)	C (±0.005)	A (±0.005)	Power (W)	Max Capacitance (pF)
RPC50-50-RXXX-X	0.050 [1.27]	0.050 [1.27]	0.010 [0.25]	0.045 [1.14]	0.012 [0.03]	15	0.35
RPC50-100-RXXX-X	0.050 [1.27]	0.100 [2.54]	0.010 [0.25]	0.045 [1.14]	0.017 [0.43]	25	0.73
RPC75-150-RXXX-X	0.075 [1.10]	0.150 [3.81]	0.010 [0.25]	0.070 [1.78]	0.040 [1.02]	50	1.65
RPC100-200-4RXXX-X	0.100 [2.54]	0.200 [5.08]	0.040 [1.02]	0.090 [2.29]	0.060 [1.52]	60	0.73
RPC230-350-4RXXX-X	0.230 [5.84]	0.350 [8.89]	0.040 [1.02]	0.220 [5.59]	0.050 [0.03]	250	2.94
RPC250-250-4RXXX-X	0.250 [6.35]	0.250 [6.35]	0.040 [1.02]	0.240 [6.10]	0.060 [1.52]	200	2.28
RPC250-250-6RXXX-X	0.250 [6.35]	0.250 [6.35]	0.060 [1.52]	0.240 [6.10]	0.060 [1.52]	125	1.52
RPC250-375-4RXXX-X	0.250 [6.35]	0.375 [9.53]	0.040 [1.02]	0.240 [6.10]	0.060 [1.52]	300	3.42
RPC250-375-1RXXX-X	0.250 [6.35]	0.375 [9.53]	0.135 [3.43]	0.240 [6.10]	0.060 [1.52]	100	1.01
RPC375-375-4RXXX-X	0.375 [9.53]	0.375 [9.53]	0.040 [1.02]	0.365 [9.27]	0.050 [1.27]	400	5.13
RPC500-500-4RXXX-X	0.500 [12.7]	0.500 [12.7]	0.040 [1.02]	0.490 [12.45]	0.040 [1.02]	500	9.13
RPC1000-1000-6RXXX-X	1.000 [25.4]	1.000 [25.4]	0.060 [1.52]	0.950 [24.13]	0.090 [2.29]	800	24.0

Aluminum Nitride Part Number	W (±0.010)	L (±0.010)	T (±0.005)	C (±0.005)	A (±0.005)	Power (W)	Capacitance MAX (pF)
RPC50-100-2NRXXX-X	0.050 [1.27]	0.100 [2.54]	0.025 [0.64]	0.045 [1.14]	0.020 [0.51]	10	0.4
RPC60-120-2NRXXX-X	0.060 [1.52]	0.120 [3.05]	0.025 [0.64]	0.055 [1.40]	0.020 [0.51]	15	0.57
RPC100-200-4NRXXX-X	0.100 [2.54]	0.200 [5.08]	0.040 [1.02]	0.090 [2.29]	0.060 [1.52]	40	1.0
RPC250-250-4NRXXX-X	0.245 [6.22]	0.245 [6.22]	0.040 [1.02]	0.130 [3.30]	0.020 [1.51]	150	3.1
RPC250-375-4NRXXX-X	0.250 [6.35]	0.375 [9.53]	0.040 [1.02]	0.198 [5.03]	0.025 [0.64]	200	4.68

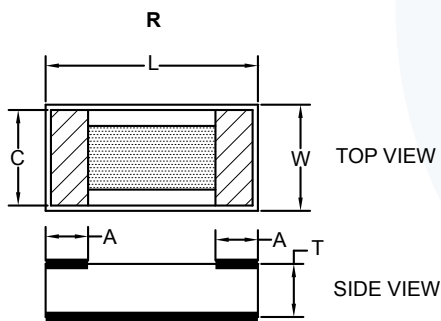

Dimensions are in inches [mm]
Tolerance: .XXX = ±0.010, .XX = ±0.015

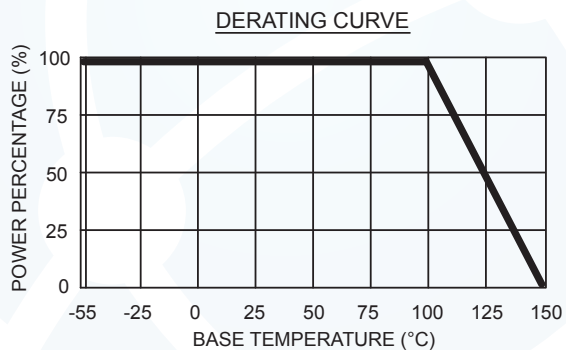

[Ordering Information on Page 38](#)

HIGH POWER CHIP RESISTORS STYLE W



General Specifications

Substrate: Beryllium Oxide or Aluminum Nitride
Resistive Film: Thick Film
Terminals: Silver
Reliability: MIL-PRF-55342

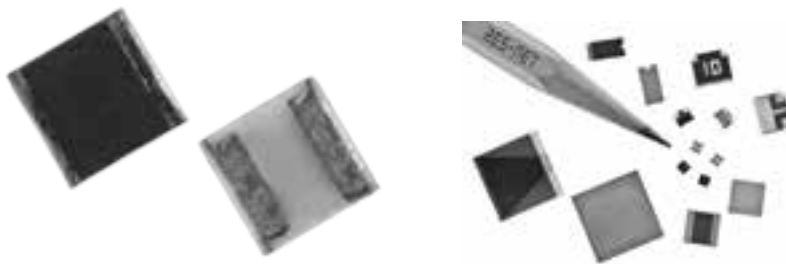

Beryllium Oxide Part Number	W (±0.010)	L (±0.010)	T (±0.005)	C (±0.005)	A (±0.005)	Power (W)	Max Capacitance (pF)
RPC50-50-WXXX-X	0.050 [1.27]	0.050 [1.27]	0.010 [0.25]	0.045 [1.14]	0.012 [0.03]	5	0.35
RPC50-100-WXXX-X	0.050 [1.27]	0.100 [2.54]	0.010 [0.25]	0.045 [1.14]	0.017 [0.43]	10	0.73
RPC75-150-WXXX-X	0.075 [1.10]	0.150 [3.81]	0.010 [0.25]	0.070 [1.78]	0.040 [1.02]	15	1.65
RPC100-200-4WXXX-X	0.100 [2.54]	0.200 [5.08]	0.040 [1.02]	0.090 [2.29]	0.060 [1.52]	20	0.73
RPC230-350-4WXXX-X	0.230 [5.84]	0.350 [8.89]	0.040 [1.02]	0.220 [5.59]	0.050 [0.03]	75	2.94
RPC250-250-4WXXX-X	0.250 [6.35]	0.250 [6.35]	0.040 [1.02]	0.240 [6.10]	0.060 [1.52]	60	2.28
RPC250-250-6WXXX-X	0.250 [6.35]	0.250 [6.35]	0.060 [1.52]	0.240 [6.10]	0.060 [1.52]	40	1.52
RPC250-375-4WXXX-X	0.250 [6.35]	0.375 [9.53]	0.040 [1.02]	0.240 [6.10]	0.040 [1.02]	100	3.42
RPC250-375-1WXXX-X	0.250 [6.35]	0.375 [9.53]	0.135 [3.43]	0.240 [6.10]	0.060 [1.52]	100	1.01
RPC375-375-4WXXX-X	0.375 [9.53]	0.375 [9.53]	0.040 [1.02]	0.365 [9.27]	0.050 [1.27]	125	5.13
RPC500-500-4WXXX-X	0.500 [12.7]	0.500 [12.7]	0.040 [1.02]	0.490 [12.45]	0.040 [1.02]	150	9.13

Aluminum Nitride Part Number	W (±0.010)	L (±0.010)	T (±0.005)	C (±0.005)	A (±0.005)	Power (W)	Max Capacitance (pF)
RPC50-100-2NWXXX-X	0.050 [1.27]	0.100 [2.54]	0.025 [0.64]	0.045 [1.14]	0.020 [0.51]	2	0.4
RPC60-120-2NWXXX-X	0.060 [1.52]	0.120 [3.05]	0.025 [0.64]	0.055 [1.40]	0.020 [0.51]	5	0.57
RPC100-200-4NWXXX-X	0.100 [2.54]	0.200 [5.08]	0.040 [1.02]	0.090 [2.29]	0.020 [0.51]	10	1.0
RPC250-250-4NWXXX-X	0.245 [6.22]	0.245 [6.22]	0.040 [1.02]	0.130 [3.30]	0.020 [0.51]	40	3.1
RPC250-375-4NWXXX-X	0.250 [6.35]	0.375 [9.53]	0.040 [1.02]	0.198 [5.03]	0.025 [0.64]	75	4.68

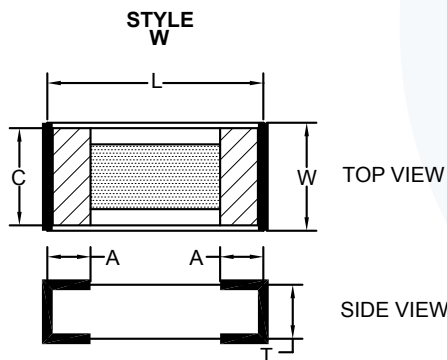

Dimensions are in inches [mm]
Tolerance: .XXX = ±0.010, .XX = ±0.015

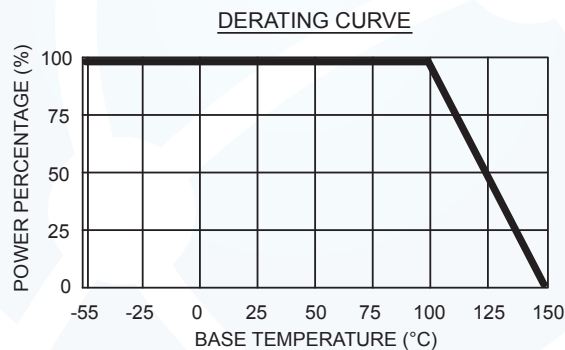

[Ordering Information on Page 38](#)

General Specifications

Substrate: Beryllium Oxide or Aluminum Nitride
Resistive Film: Thick Film
Terminals: Silver
Reliability: MIL-PRF-55342

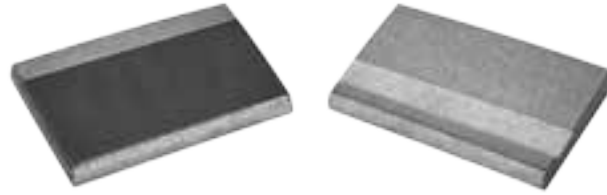

Beryllium Oxide Part Number	W (±0.010)	L (±0.010)	T (±0.005)	C (±0.005)	A (±0.005)	B (±0.005)	Power (W)	Max Capacitance (pF)
RPC50-50-ZXXX-X	0.050 [1.27]	0.050 [1.27]	0.010 [0.25]	0.045 [1.14]	0.012 [0.03]	0.010 [0.03]	10	0.35
RPC50-80-2ZXXX-X	0.050 [1.27]	0.080 [2.03]	0.025 [0.64]	0.045 [1.14]	0.017 [0.43]	0.015 [0.38]	10	0.60
RPC50-100-ZXXX-X	0.050 [1.27]	0.100 [2.54]	0.010 [0.25]	0.045 [1.14]	0.017 [0.43]	0.015 [0.43]	15	0.65
RPC60-120-2ZXXX-X	0.060 [1.52]	0.120 [3.05]	0.025 [0.64]	0.055 [1.40]	0.020 [0.51]	0.015 [0.38]	10	0.7
RPC75-150-ZXXX-X	0.075 [1.10]	0.150 [3.81]	0.010 [0.25]	0.070 [1.78]	0.040 [1.02]	0.015 [1.02]	35	1.65
RPC100-200-4ZXXX-X	0.100 [2.54]	0.200 [5.08]	0.040 [1.02]	0.090 [2.29]	0.060 [1.52]	0.025 [1.52]	40	0.73
RPC230-350-4ZXXX-X	0.230 [5.84]	0.350 [8.89]	0.040 [1.02]	0.220 [5.59]	0.050 [0.03]	0.040 [1.02]	40	2.94
RPC250-250-4ZXXX-X	0.250 [6.35]	0.250 [6.35]	0.040 [1.02]	0.240 [6.10]	0.060 [1.52]	0.040 [1.02]	200	2.28
RPC250-250-6ZXXX-X	0.250 [6.35]	0.250 [6.35]	0.060 [1.52]	0.240 [6.10]	0.060 [1.52]	0.040 [1.02]	75	1.52
RPC250-375-4ZXXX-X	0.250 [6.35]	0.375 [9.53]	0.040 [1.02]	0.240 [6.10]	0.040 [1.02]	0.040 [1.02]	200	3.92
RPC250-375-1ZXXX-X	0.250 [6.35]	0.375 [9.53]	0.135 [3.43]	0.240 [6.10]	0.060 [1.52]	0.040 [1.02]	75	1.01
RPC375-375-4ZXXX-X	0.375 [9.53]	0.375 [9.53]	0.040 [1.02]	0.365 [9.27]	0.050 [1.27]	0.040 [1.02]	300	5.13
RPC500-500-4ZXXX-X	0.500 [12.7]	0.500 [12.7]	0.040 [1.02]	0.490 [12.45]	0.040 [1.02]	0.040 [1.02]	350	9.13

Aluminum Nitride Part Number	W (±0.010)	L (±0.010)	T (±0.005)	C (±0.005)	A (±0.005)	B (±0.005)	Power (W)	Capacitance MAX (pF)
RPC50-100-2NZXXX-X	0.050 [1.27]	0.100 [2.54]	0.025 [0.64]	0.045 [1.14]	0.020 [0.51]	0.015 [0.38]	8	0.4
RPC60-120-2NZXXX-X	0.060 [1.52]	0.120 [3.05]	0.025 [0.64]	0.055 [1.40]	0.020 [0.51]	0.015 [0.38]	10	0.57
RPC100-200-4NZXXX-X	0.100 [2.54]	0.200 [5.08]	0.040 [1.02]	0.090 [2.29]	0.020 [0.51]	0.025 [0.63]	30	1.00
RPC250-250-4NZXXX-X	0.245 [6.22]	0.245 [6.22]	0.040 [1.02]	0.130 [3.30]	0.020 [0.51]	0.040 [1.02]	100	3.1
RPC250-375-4NZXXX-X	0.250 [6.35]	0.375 [9.53]	0.040 [1.02]	0.198 [5.03]	0.025 [0.64]	0.040 [1.02]	150	4.68

STYLE Z

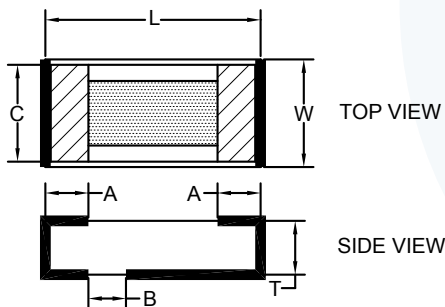

Dimensions are in inches [mm]
Tolerance: .XXX = ±0.010, .XX = ±0.015

DERATING CURVE

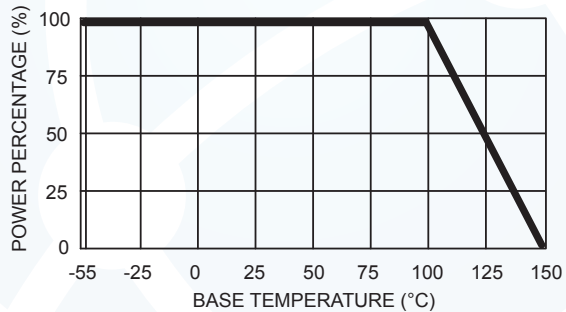

[Ordering Information on Page 38](#)

General Specifications

Substrate: Beryllium Oxide or Aluminum Nitride
 Resistive Film: Thick Film
 Tabs: Silver Plated Beryllium Oxide
 Cover: Alumina

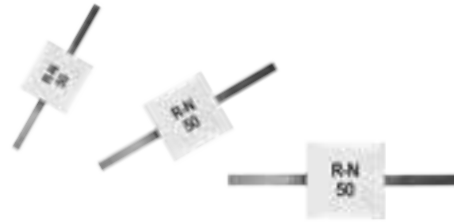

Beryllium Oxide Part Number	W (±0.010)	L (±0.010)	T (MAX)	C (±0.005)	A (MIN)	Power (W)	Cap. max (pF)
RPC100-200-4RXXX-XC	0.100 [2.54]	0.200 [5.08]	0.088 [2.24]	0.040 [1.02]	0.125 [3.18]	60	0.73
RPC230-350-4RXXX-XC	0.230 [5.84]	0.350 [8.89]	0.088 [2.24]	0.040 [1.02]	0.125 [3.18]	250	2.94
RPC250-250-4RXXX-XC	0.250 [6.35]	0.250 [6.35]	0.088 [2.24]	0.060 [1.52]	0.250 [6.35]	200	2.28
RPC250-250-6RXXX-XC	0.250 [6.35]	0.250 [6.35]	0.108 [2.74]	0.060 [1.52]	0.250 [6.35]	125	1.52
RPC250-375-1RXXX-XC	0.250 [6.35]	0.375 [9.53]	0.143 [3.63]	0.250 [6.35]	0.125 [3.18]	100	1.01
RPC250-375-4RXXX-XC	0.250 [6.35]	0.375 [9.53]	0.173 [4.39]	0.250 [6.35]	0.125 [3.18]	300	3.42
RPC375-375-4RXXX-XC	0.375 [9.53]	0.375 [9.53]	0.085 [2.16]	0.060 [1.52]	0.125 [3.18]	400	5.13
RPC500-500-4RXXX-XC	0.500 [12.7]	0.500 [12.7]	0.125 [3.18]	0.120 [3.05]	0.125 [3.18]	500	9.13
RPC1000-1000-6RXXX-XC	1.000 [25.4]	1.000 [25.4]	0.105 [2.67]	0.200 [5.08]	0.125 [3.18]	800	24.0

Aluminum Nitride Part Number	W (±0.010)	L (±0.010)	T (MAX)	C (±0.005)	A (MIN)	Power (W)	Cap. max (pF)
RPC100-200-4NRXXX-XC	0.100 [2.54]	0.200 [5.08]	0.088 [2.24]	0.040 [1.02]	0.125 [3.18]	40	1.0
RPC230-350-4NRXXX-XC	0.230 [5.84]	0.350 [8.89]	0.088 [2.24]	0.040 [1.02]	0.125 [3.18]	175	4.0
RPC250-250-4NRXXX-XC	0.245 [6.22]	0.245 [6.22]	0.088 [2.24]	0.060 [1.52]	0.250 [6.35]	150	3.1
RPC250-375-4NRXXX-XC	0.250 [6.35]	0.375 [9.53]	0.143 [3.63]	0.250 [6.35]	0.125 [3.18]	200	4.68
RPC375-375-4NRXXX-XC	0.375 [9.53]	0.375 [9.53]	0.085 [2.16]	0.060 [1.52]	0.125 [3.18]	250	7.0
RPC500-500-4NRXXX-XC	0.500 [12.7]	0.500 [12.7]	0.125 [3.18]	0.120 [3.05]	0.125 [3.18]	325	12.5
RPC1000-1000-6NRXXX-XC	1.000 [25.4]	1.000 [25.4]	0.105 [2.67]	0.200 [5.08]	0.125 [3.18]	800	50.0

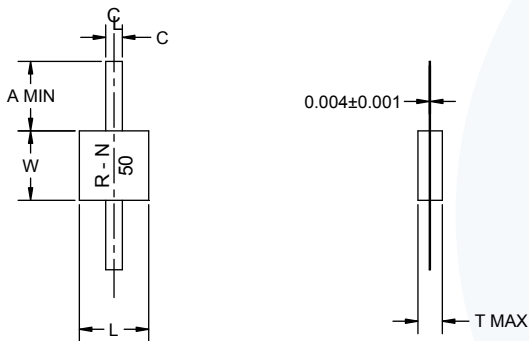

Dimensions are in inches [mm], Tolerance: .XXX = ±0.010, .XX = ±0.015

DERATING CURVE

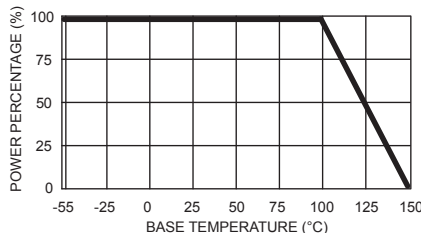

Ordering Information:

Example: **RPC 50 100 -2 N R 50 -5 C**

Series _____ ↑
 Size _____ ↑
 Thickness: _____ ↑
 No Designation: 0.010"
 2: 0.025"
 4: 0.040"
 6: 0.060"
 1: 0.135"
 Substrate: _____ ↑
 No Designation: Beryllium Oxide
 N: Aluminum Nitride
 Style: _____ ↑
 R: Resistor
 Resistance (Ohms) _____ ↑
 Tolerance (±%): _____ ↑
 1:1%, 2:2%, 5:5%
 Tab & Cover Indicator (C) _____ ↑

FLANGE RESISTORS



General Specifications

Substrate: Beryllium Oxide
 Resistive Film: Thick Film
 Resistance: XXX = 0.5 to 1 MOhm
 Tabs: Silver Plated Beryllium Copper
 Flange: Nickel Plated Copper
 Cover: Alumina
 Operating Temperature: -55°C to +150°C



Part Number	Power (W)	Figure
RPR300-20-XXX-Y	20	1
RPS100R-XXX-Y	100	2
RPR515-20-XXX-Y	20	3
RPR515-30-XXX-Y	30	3
RPR515-100-XXX-Y	100	3
RPR800-40-XXX-Y	40	4
RPR800-100-XXX-Y	100	4
RPR820-150-XXX-Y	150	5

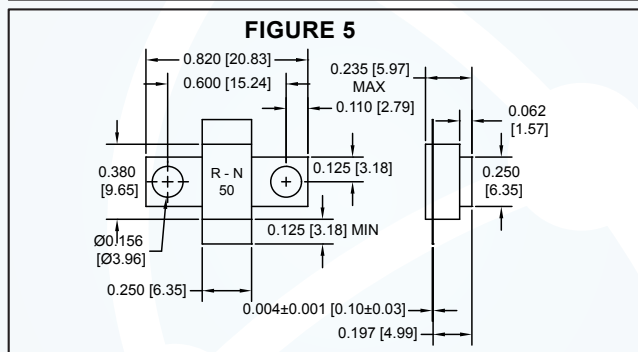
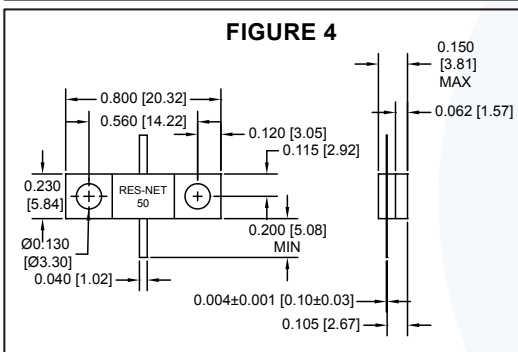
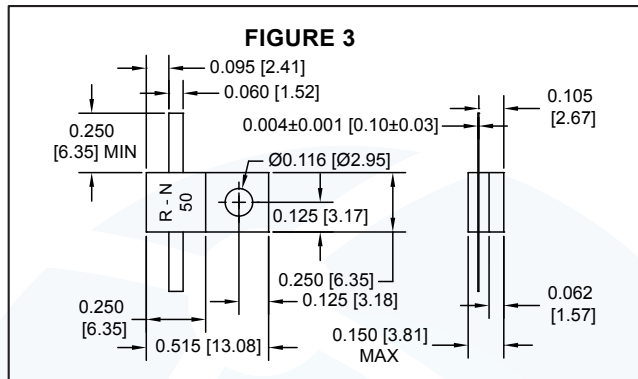
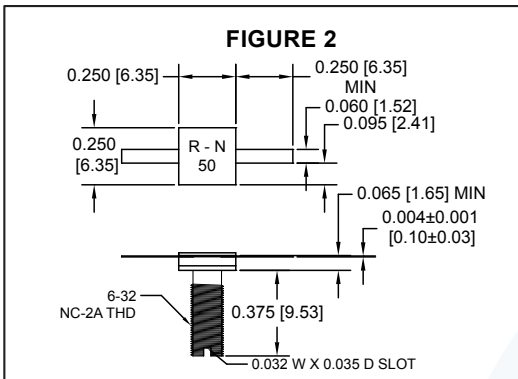
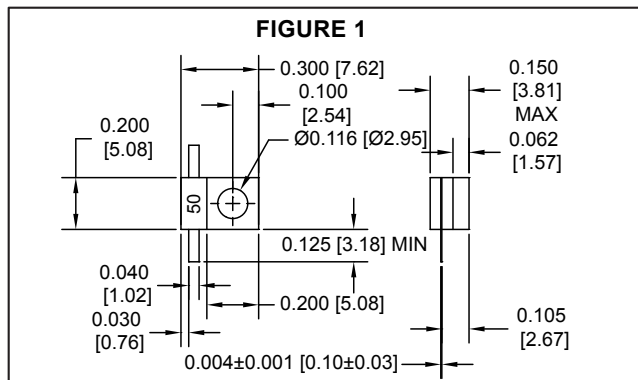

Ordering Information:

Example: **RPR 800 100 50 5**

Series ————
 Length Size ————
 Power Rating ————
 Resistance ————
 Tolerance (±%): ————
 1:1%, 2:2%, 5:5%

Dimensions are in inches [mm]
 Tolerance: .XXX = ±0.010
 .XX = ±0.015

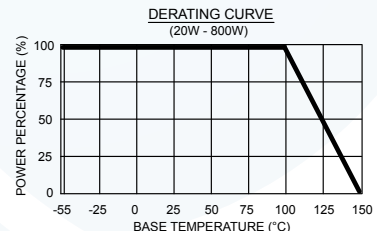

General Specifications

Substrate: Beryllium Oxide
 Resistive Film: Thick Film
 Resistance: XXX = 0.5 to 1 MOhm
 Tabs: Silver Plated Beryllium Copper
 Flange: Nickel Plated Copper
 Cover: Alumina
 Operating Temperature: -55°C to +150°C

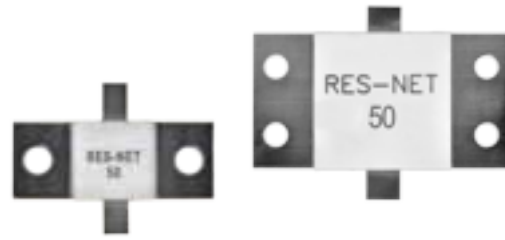

Part Number	Power (W)	Figure
RPR975-250-XXX-Y	250	1
RPR1100-400-XXX-Y	400	2
RPR1100-500-XXX-Y	500	3
RPR1250-500-XXX-Y	500	4
RPR1900-800-XXX-Y	800	5

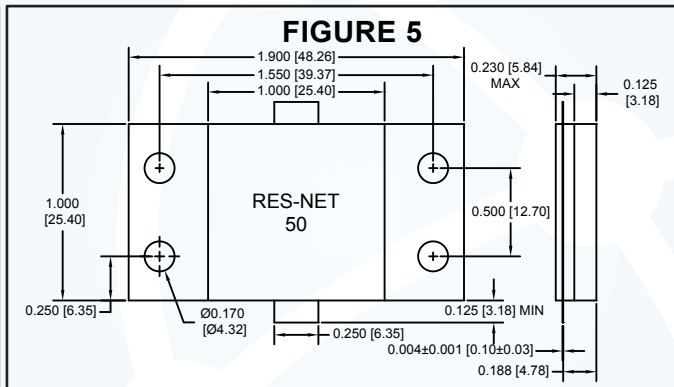
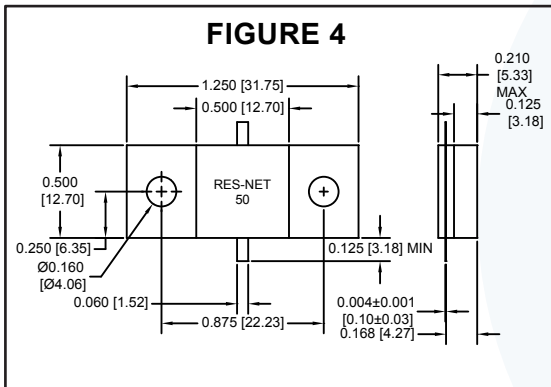
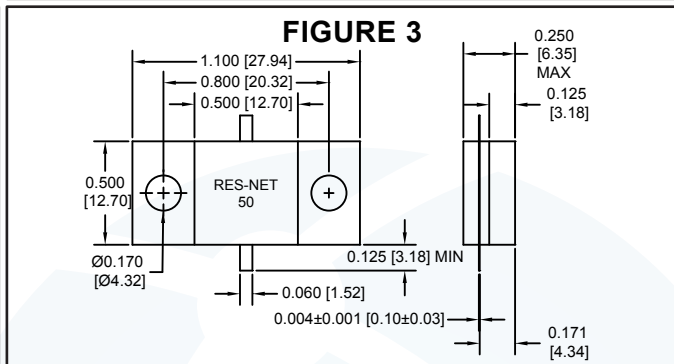
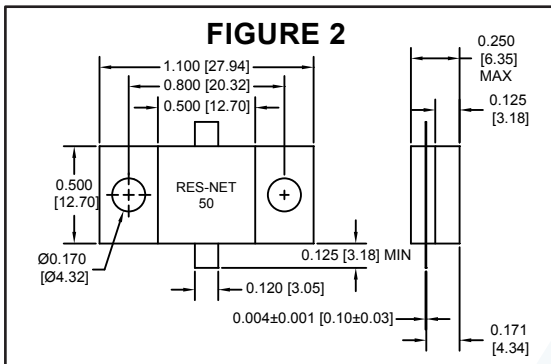
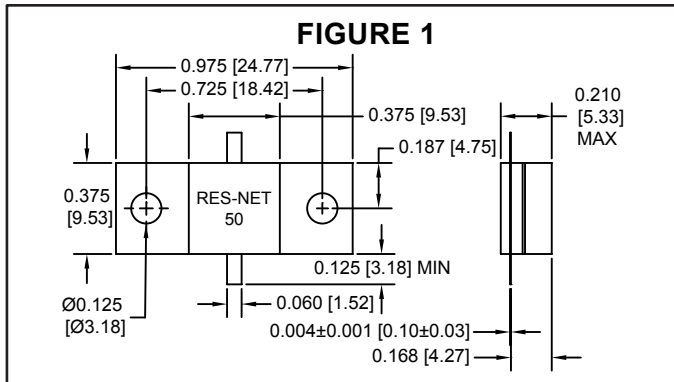

Ordering Information:

Example: RPR 1900 800 50 5

Series ———→
 Length Size ———→
 Power Rating ———→
 Resistance ———→
 Tolerance (±%) ———→
 1:1%, 2:2%, 5:5%

Dimensions are in inches [mm]
 Tolerance: .XXX = ±0.010
 .XX = ±0.015

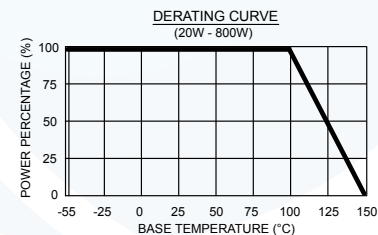

FLANGE RESISTORS



General Specifications

Substrate: Beryllium Oxide
 Resistive Film: Thick Film
 Resistance: XXX = 25, 50, 100 Ohms
 Tabs: Silver Plated Beryllium Copper
 Flange: Nickel Plated Copper
 Cover: Alumina
 Operating Temperature: -55°C to +150°C



Part Number	Power (W)	Figure
RPR1900-1000-XXX-Y	1000	11
RPR1900-1200-XXX-Y	1200	12

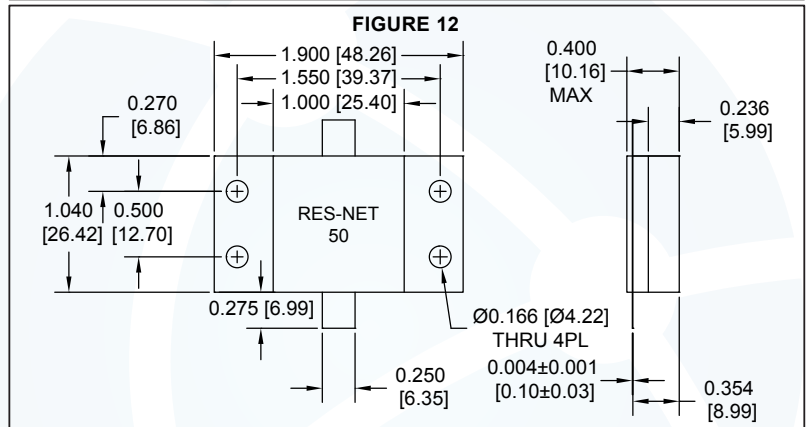
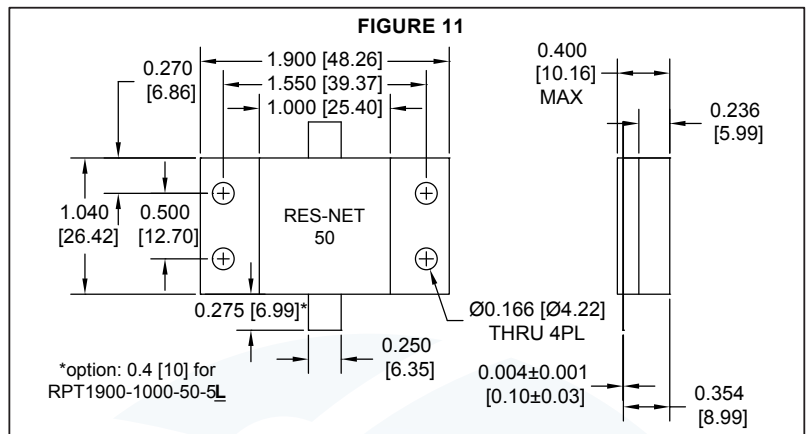
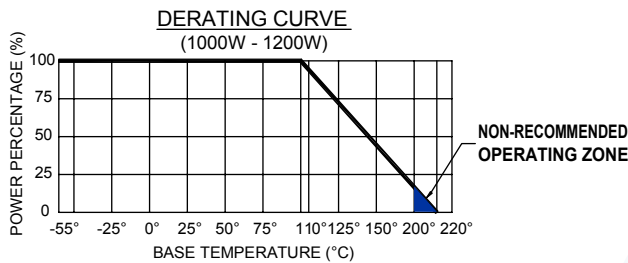

Dimensions are in inches [mm], Tolerance: .XXX = ±0.010, .XX = ±0.015

Ordering Information:

Example:

RPR 1900 1200 50 5

Series ———— ↑
 Length Size ———— ↑
 Power Rating ———— ↑
 Resistance ———— ↑
 Tolerance (±5%) ———— ↑



General Specifications

Substrate: Beryllium Oxide
 Resistive Film: Thick Film
 Resistance: XXX = 25, 50, 100, 200 Ohms
 Tabs: Silver Plated Beryllium Copper
 Flange: Nickel Plated Copper
 Cover: Alumina
 Operating Temperature: -55°C to +150°C



Part Number	Power (W)
RPR1900-1500-XXX-Y	1500

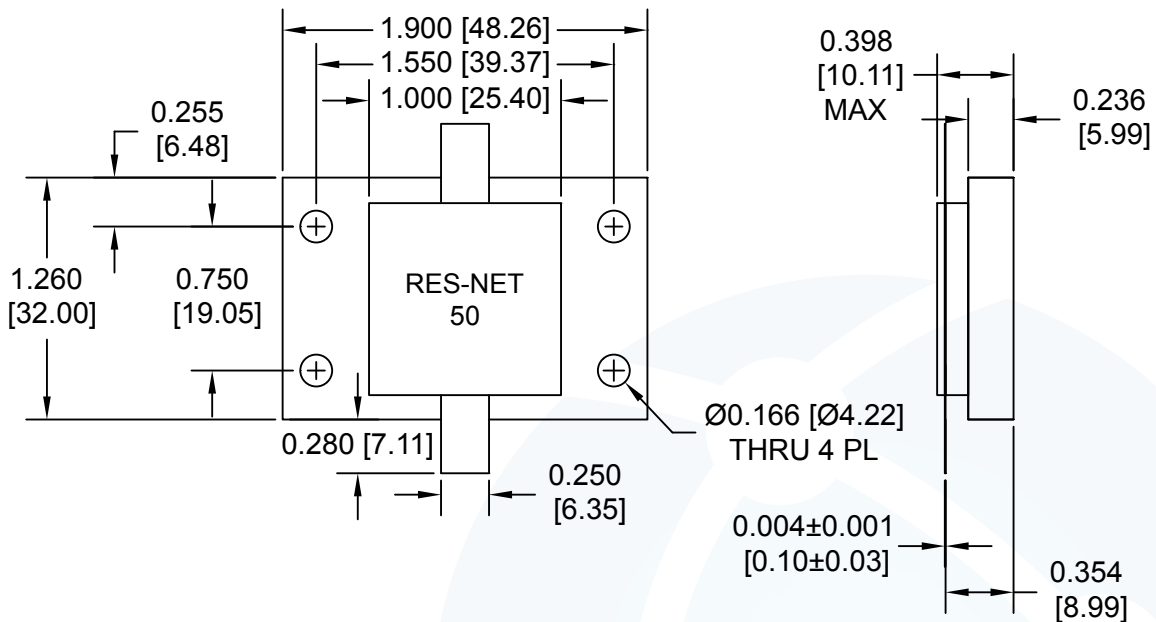

Dimensions are in inches [mm], Tolerance: .XXX = ±0.010, .XX = ±0.015

Ordering Information:

Example:

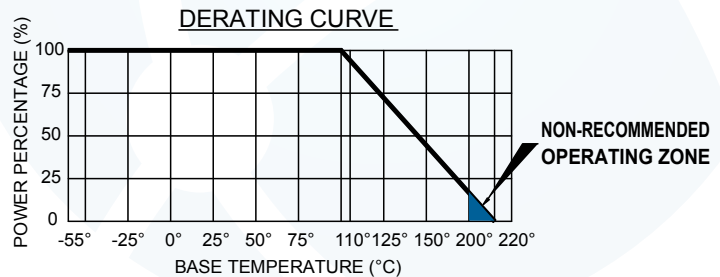
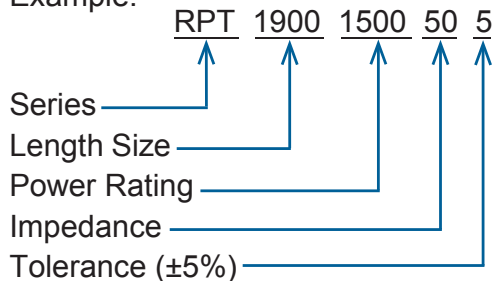

ROD RESISTORS



General Specifications

Substrate: Alumina, Beryllium Oxide,
or Aluminum Nitride

Resistive Material: Thin Film (NiCr)

Terminal Ends: Tin Plated over Nickel
(Gold Plating also available)

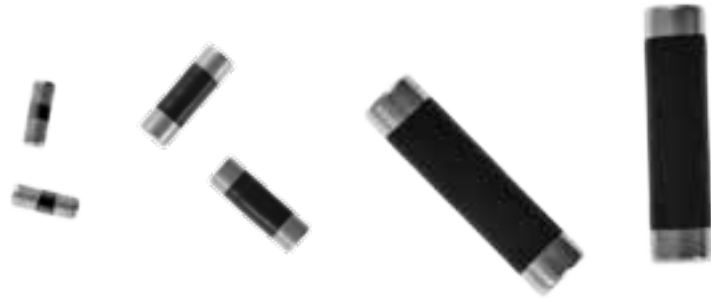

Resistance Range	Tolerance	Temperature Coefficient	Temperature Range
10-500 Ohms	±1%, ±2%, or ±5%	±75ppm/°C	-65° to +175°C

ALUMINA ROD RESISTORS

Part Number	O.D. ±0.003	L ±0.010	T ±0.015	Power (W)
R20L125	0.020 [0.51]	0.125 [3.18]	0.035 [0.89]	0.25
R40L115	0.040 [1.02]	0.115 [2.92]	0.031 [0.79]	1.00
R40L125	0.040 [1.02]	0.125 [3.18]	0.035 [0.89]	1.00
R62L187	0.062 [1.57]	0.187 [4.75]	0.063 [1.60]	2.00
R62L375	0.062 [1.57]	0.375 [9.53]	0.047 [1.19]	2.00
R80L187	0.080 [2.03]	0.187 [4.75]	0.063 [1.60]	2.00
R125L250H*	0.125 [3.18]	0.250 [6.35]	0.063 [1.60]	1.00
R125L406	0.125 [3.18]	0.406 [10.31]	0.109 [2.77]	2.00
R125L500	0.125 [3.18]	0.500 [12.70]	0.063 [1.60]	2.00

BERYLLIUM OXIDE ROD RESISTORS

Part Number	O.D. ±0.003	L ±0.010	T ±0.015	Power (W)
R40B115	0.040 [1.02]	0.115 [2.92]	0.031 [0.79]	5.0
R40B125	0.040 [1.02]	0.125 [3.18]	0.035 [0.89]	5.0
R60B120	0.060 [1.52]	0.120 [3.05]	0.031 [0.79]	10.0
R62B187	0.062 [1.57]	0.187 [4.75]	0.063 [1.60]	10.0
R62B375	0.062 [1.57]	0.375 [9.53]	0.047 [1.19]	10.0
R80B187	0.080 [2.03]	0.187 [4.75]	0.063 [1.60]	20.0
R125B500	0.125 [3.18]	0.500 [12.70]	0.063 [1.60]	25.0
R250B750	0.250 [6.35]	0.750 [19.05]	0.125 [3.18]	40.0
R375B750	0.375 [9.53]	0.750 [19.05]	0.125 [3.18]	75.0

Specifications continued on next page.

Mechanical Outline

*for R125L250H Only

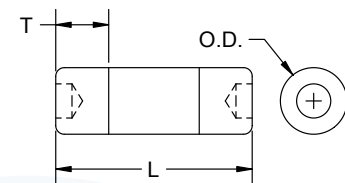

Mechanical Outline

(For all except R125L250H)

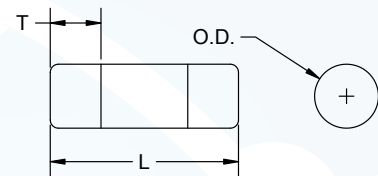

Dimensions: Inches [mm]

Derating Curve

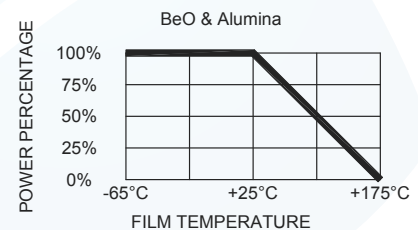

General Specifications

Substrate: Alumina, Beryllium Oxide, or Aluminum Nitride

Resistive Material: Thin Film (NiCr)

Terminal Ends: Tin Plated over Nickel
(Gold Plating also available)



ALUMINUM NITRIDE ROD RESISTORS

Part Number	O.D. ± 0.003	L ± 0.010	T ± 0.015	Power (W)
R40N115	0.040 [1.02]	0.115 [2.92]	0.031 [0.79]	5.0
R60N120	0.060 [1.52]	0.120 [3.05]	0.031 [0.79]	10.0
R62N187	0.062 [1.57]	0.187 [4.75]	0.063 [1.60]	10.0
R62N375	0.062 [1.57]	0.375 [9.53]	0.047 [1.19]	10.0
R125N500	0.125 [3.15]	0.500 [12.70]	0.063 [1.60]	25.0
R250N750	0.250 [6.35]	0.750 [19.05]	0.125 [3.15]	40.0
R375N750	0.375 [9.53]	0.750 [19.05]	0.125 [3.15]	75.0

Mechanical Outline

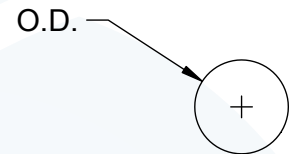
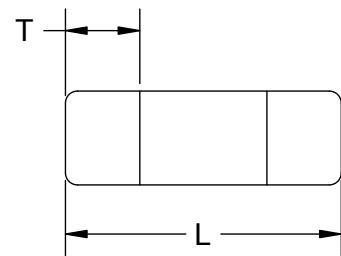

Dimensions: Inches [mm]

Ordering Information:

Example:

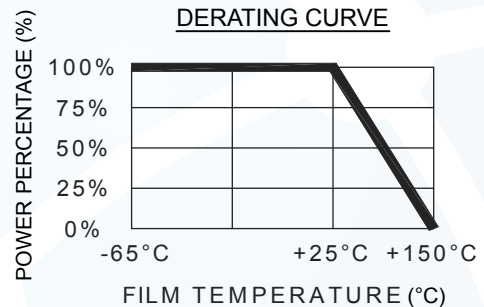
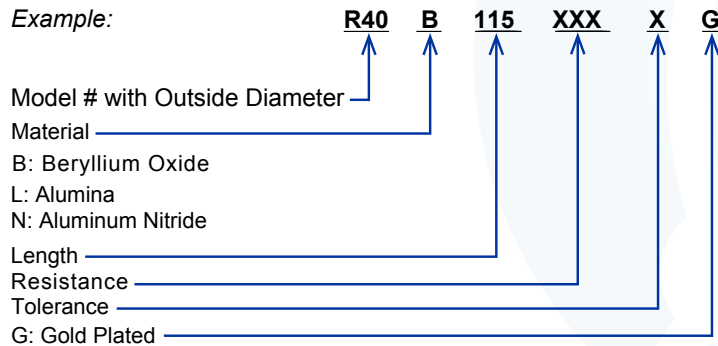

DISC RESISTORS



General Specifications

Disc Material: Beryllium Oxide Ceramic
 Terminations: Silver with Tin over Nickel Plating

Part Number	Resistance (Ohms)	Tolerance	Temperature Range	Temperature Coefficient Of Resistance PPM/ °C	Power (W)
RD05	< 1 1-50 > 50	±20% ±10% ±5%	-55° to +150°C	±100	5
RD10	< 1 1-50 > 50	±20% ±10% ±5%	-55° to +150°C	±100	10

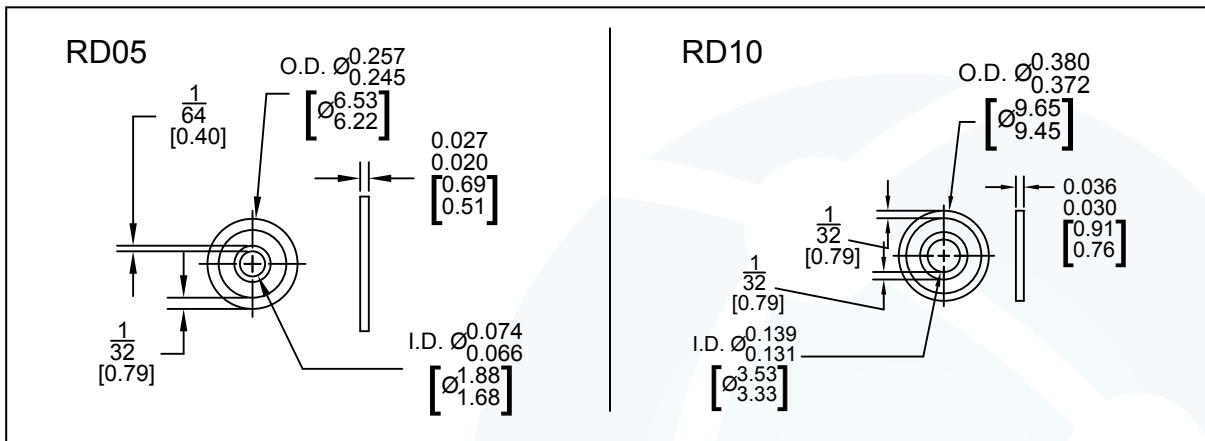

Dimensions are in inches [mm], Tolerance: .XXX = ±0.010, .XX = ±0.015

Ordering Information:

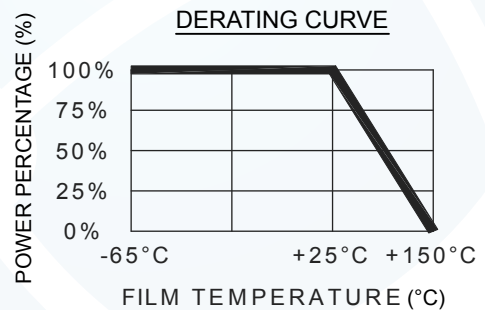
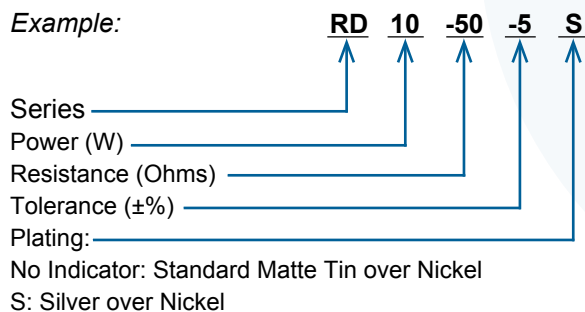

RF & microwave terminations play an important role in many high frequency circuits and systems. They are used to absorb unwanted energy in electrical circuits by converting the RF energy into heat. In addition, terminations are used to terminate transmission lines that have specific characteristic impedance, typically 50 Ohms. Standard termination values are 50 Ohms for maximum power transfer; however, 75 Ohm terminations are also used in broadcast applications.

Res-Net Microwave, Inc. offers a full line of high power RF terminations including: chip, surface mount, tab & cover, flange mounted, stripline, convection and conduction cooled types. Our terminations are designed for the best impedance match and broadband performance.

Res-Net terminations are capable of handling power up to 1.5kW and frequencies up to 30GHz. For best power and frequency performance, our terminations are made from: Alumina, Beryllium Oxide (BeO), Aluminum Nitrate (AlN), and Chemical Vapor Deposition (CVD) diamond substrate materials.



Features:

- Frequency Range from DC to 30GHz
- Power Handling up to 1500 Watts
- Small size, many different styles
- Alumina, ALN, BeO or CVD Diamond Substrates
- Tin/Led and Lead Free Plating Options
- High Reliability Versions Available

Applications:

- High Power Amplifiers
- Broadcast
- Instrumentation
- Telecom
- Military
- Satellite

HIGH POWER CHIP TERMINATIONS STYLE T



General Specifications

Substrate: Beryllium Oxide or Aluminum Nitride
Resistive Film: Thick Film
Terminals: Silver
Reliability: MIL-PRF-55342

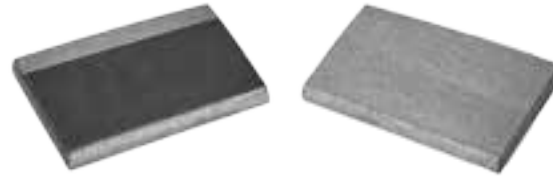

Beryllium Oxide Part Number	W (±0.010)	L (±0.010)	T (±0.005)	C (±0.005)	A	Power (W)	Frequency (GHz)	VSWR (max)
RPC50-50-T50-X	0.050 [1.27]	0.050 [1.27]	0.010 [0.25]	0.045 [1.14]	0.012 [0.03]	8	DC – 4.0	1.25:1
RPC50-100-T50-X	0.050 [1.27]	0.100 [2.54]	0.010 [0.25]	0.045 [1.14]	0.017 [0.43]	15	DC – 4.0	1.25:1
RPC75-150-T50-X	0.075 [1.10]	0.150 [3.81]	0.010 [0.25]	0.070 [1.78]	0.040 [1.02]	30	DC – 6.0	1.25:1
RPC100-200-4T50-X	0.100 [2.54]	0.200 [5.08]	0.040 [1.02]	0.090 [2.29]	0.060 [1.52]	40	DC – 6.0	1.25:1
RPC230-350-4T50-X	0.230 [5.84]	0.350 [8.89]	0.040 [1.02]	0.220 [5.59]	0.050 [0.03]	150	DC – 4.0	1.25:1
RPC250-250-4T50-X	0.250 [6.35]	0.250 [6.35]	0.040 [1.02]	0.240 [6.10]	0.060 [1.52]	175	DC – 2.0	1.35:1
RPC250-250-6T50-X	0.250 [6.35]	0.250 [6.35]	0.060 [1.52]	0.240 [6.10]	0.060 [1.52]	100	DC – 2.0	1.35:1
RPC250-375-4T50-X	0.250 [6.35]	0.375 [9.53]	0.040 [1.02]	0.240 [6.10]	0.050 [1.27] *0.030 [0.76]	200	DC – 2.0	1.25:1
RPC250-375-1T50-X	0.250 [6.35]	0.375 [9.53]	0.135 [3.43]	0.240 [6.10]	0.060 [1.52]	75	DC – 1.5	1.35:1
RPC375-375-4T50-X	0.375 [9.53]	0.375 [9.53]	0.040 [1.02]	0.365 [9.27]	0.050 [1.27]	250	DC – 2.0	1.2:1
RPC500-500-4T50-X	0.500 [12.7]	0.500 [12.7]	0.040 [1.02]	0.490 [12.45]	0.040 [1.02]	500	DC – 1.0	1.2:1

Aluminum Nitride Part Number	W (±0.010)	L (±0.010)	T (±0.005)	C (±0.005)	A	Power (W)	Frequency (GHz)	VSWR (max)
RPC50-100-2NT50-X	0.050 [1.27]	0.100 [2.54]	0.025 [0.64]	0.045 [1.14]	0.020 [0.51]	8	DC – 4.0	1.25:1
RPC60-120-2NT50-X	0.060 [1.52]	0.120 [3.05]	0.025 [0.64]	0.055 [1.40]	0.020 [0.51]	10	DC – 4.0	1.25:1
RPC100-200-4NT50-X	0.100 [2.54]	0.200 [5.08]	0.040 [1.02]	0.090 [2.29]	0.135 [3.43] *0.020 [0.51]	30	DC – 6.0	1.25:1
RPC250-250-4NT50-X	0.245 [6.22]	0.245 [6.22]	0.040 [1.02]	0.130 [3.30]	0.135 [3.43] *0.020 [0.51]	75	DC – 3.0	1.25:1
RPC250-375-4NT50-X	0.250 [6.35]	0.375 [9.53]	0.040 [1.02]	0.198 [5.03]	0.050 [1.27] *0.025 [0.64]	125	DC – 2.0	1.25:1

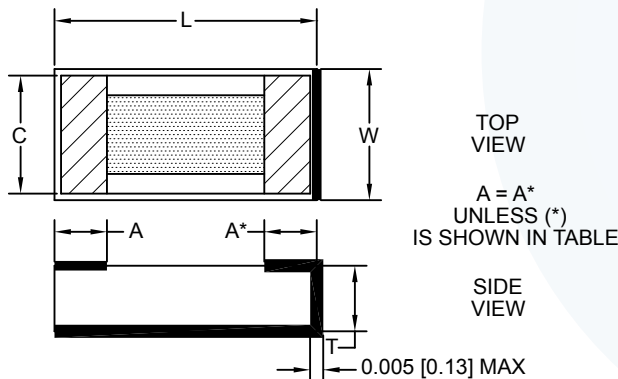

Dimensions are in inches [mm]
Tolerance: .XXX = ±0.010, .XX = ±0.015

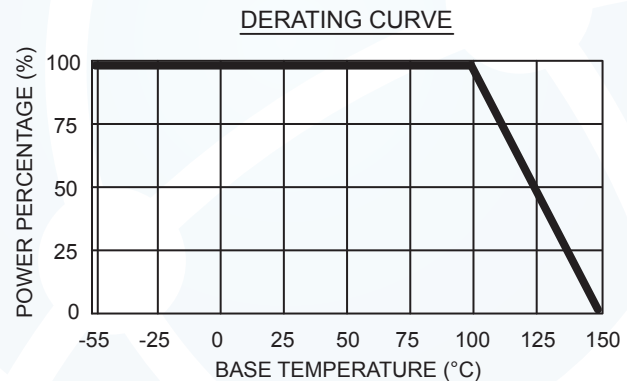

[Ordering Information on Page 51](#)

HIGH POWER CHIP TERMINATIONS STYLE T

General Specifications

Substrate: Alumina
Resistive Film: Thick Film
Terminals: Silver
Reliability: MIL-PRF-55342

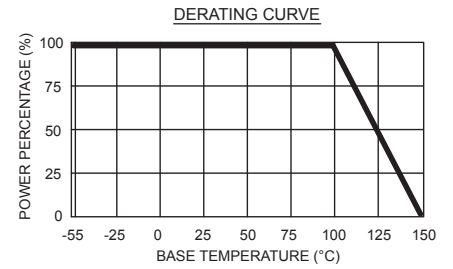
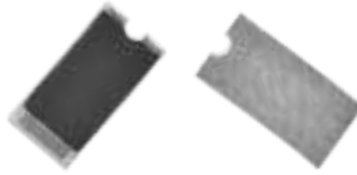

Part Number	Impedance (Ohms)	Tolerance	Frequency (GHz)	VSWR (max)	Temperature Range	Power (W)
RPC4020-10AT50-5	50	±5%	DC-20	1.35:1	0° to +125°C	1
RPC8050-15AT50-5	50	±5%	DC-12	1.50:1	0° to +125°C	2
RPC100200-2AT50-5	50	±5%	DC-6	1.25:1	0° to +125°C	20

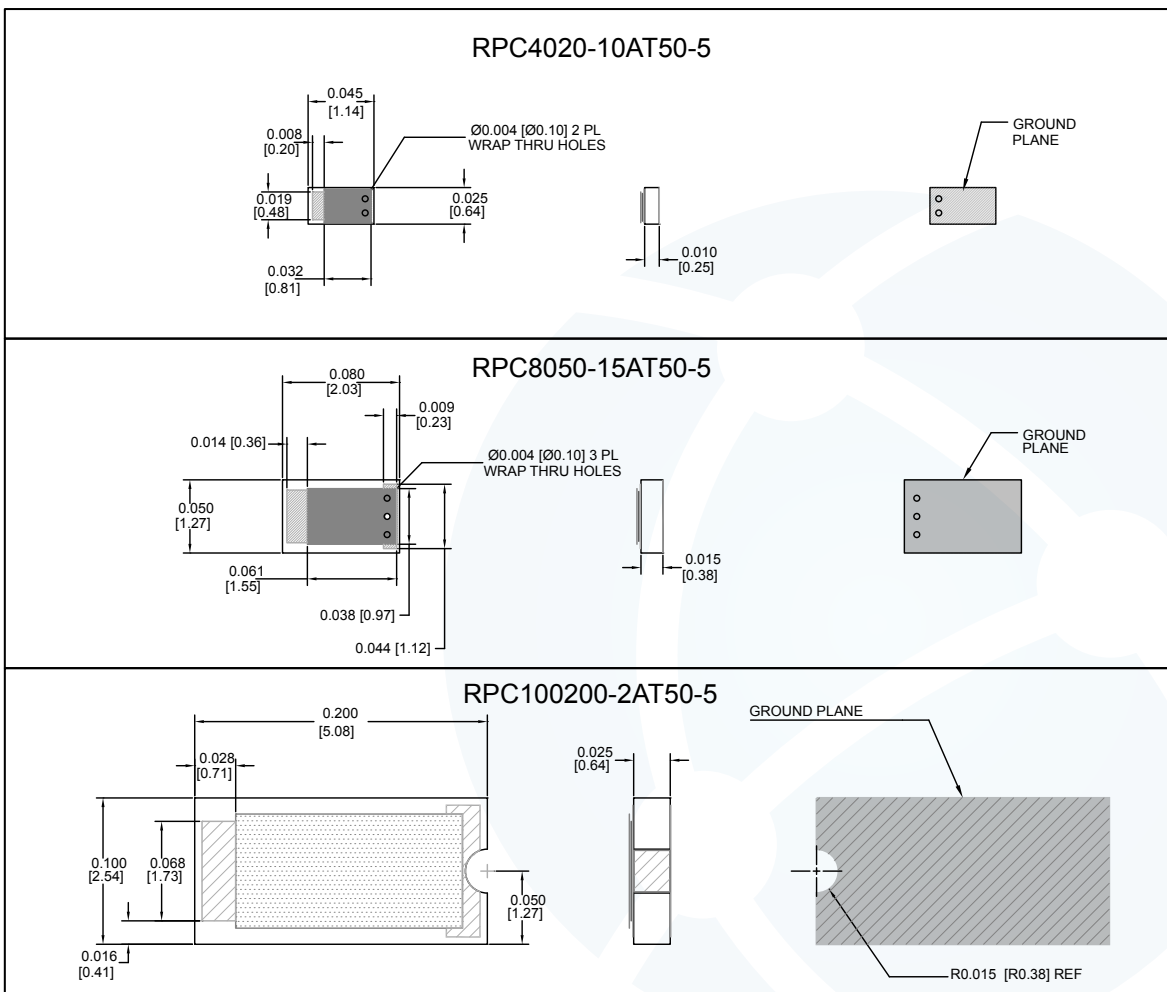

HIGH POWER CHIP TERMINATIONS STYLE Z



General Specifications

Substrate: Beryllium Oxide or Aluminum Nitride
Resistive Film: Thick Film
Terminals: Silver
Reliability: MIL-PRF-55342

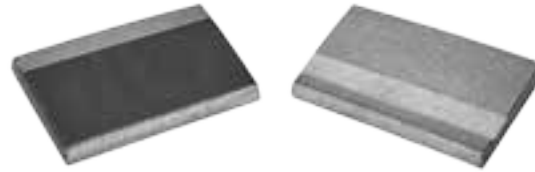

Beryllium Oxide Part Number	W (±0.010)	L (±0.010)	T (±0.005)	C (±0.005)	A inches (mm)	B inches (mm)	Power (W)	Frequency (GHz)	VSWR (max)
RPC50-50-Z50-X	0.050 [1.27]	0.050 [1.27]	0.010 [0.25]	0.045 [1.14]	0.012 [0.03]	0.010 [0.03]	10	DC - 4.0	1.25:1
RPC50-80-Z250-X	0.050 [1.27]	0.080 [2.03]	0.025 [0.64]	0.045 [1.14]	0.017 [0.43]	0.015 [0.38]	10	DC - 4.0	1.25:1
RPC50-100-Z50-X	0.050 [1.27]	0.100 [2.54]	0.010 [0.25]	0.045 [1.14]	0.017 [0.43]	0.015 [0.43]	15	DC - 4.0	1.25:1
RPC60-120-Z250-X	0.060 [1.52]	0.120 [3.05]	0.025 [0.64]	0.055 [1.40]	0.020 [0.51]	0.015 [0.38]	10	DC - 4.0	1.25:1
RPC80-100-Z250-X	0.080 [2.03]	0.100 [2.54]	0.025 [0.64]	0.028 [0.71]	0.013 [0.33]	0.013 [0.33]	20	DC - 18.0	1.45:1
RPC75-150-Z50-X	0.075 [1.10]	0.150 [3.81]	0.010 [0.25]	0.070 [1.78]	0.040 [1.02]	0.015 [1.02]	35	DC - 6.0	1.25:1
RPC100-200-4Z50-X	0.100 [2.54]	0.200 [5.08]	0.040 [1.02]	0.090 [2.29]	0.060 [1.52]	0.025 [1.52]	40	DC - 6.0	1.25:1
RPC230-350-4Z50-X	0.230 [5.84]	0.350 [8.89]	0.040 [1.02]	0.220 [5.59]	0.050 [0.03]	0.040 [1.02]	40	DC - 4.0	1.25:1
RPC250-250-4Z50-X	0.250 [6.35]	0.250 [6.35]	0.040 [1.02]	0.240 [6.10]	0.060 [1.52]	0.040 [1.02]	200	DC - 2.0	1.35:1
RPC250-250-6Z50-X	0.250 [6.35]	0.250 [6.35]	0.060 [1.52]	0.240 [6.10]	0.060 [1.52]	0.040 [1.02]	75	DC - 2.0	1.35:1
RPC250-375-4Z50-X	0.250 [6.35]	0.375 [9.53]	0.040 [1.02]	0.240 [6.10]	0.040 [1.02]	0.040 [1.02]	200	DC - 2.0	1.25:1
RPC250-375-1Z50-X	0.250 [6.35]	0.375 [9.53]	0.135 [3.43]	0.240 [6.10]	0.060 [1.52]	0.040 [1.02]	75	DC - 1.5	1.35:1
RPC375-375-4Z50-X	0.375 [9.53]	0.375 [9.53]	0.040 [1.02]	0.365 [9.27]	0.050 [1.27]	0.040 [1.02]	300	DC - 2.0	1.2:1
RPC500-500-4Z50-X	0.500 [12.7]	0.500 [12.7]	0.040 [1.02]	0.490 [12.45]	0.040 [1.02]	0.040 [1.02]	350	DC - 1	1.2:1

Aluminum Nitride Part Number	W (±0.010)	L (±0.010)	T (±0.005)	C (±0.005)	A inches (mm)	B inches (mm)	Power MAX (W)	Frequency (GHz)	VSWR MAX
RPC50-100-2NZ50-X	0.050 [1.27]	0.100 [2.54]	0.025 [0.64]	0.045 [1.14]	0.020 [0.51]	0.015 [0.38]	8	DC - 4.0	1.25:1
RPC60-120-2NZ50-X	0.060 [1.52]	0.120 [3.05]	0.025 [0.64]	0.055 [1.40]	0.020 [0.51]	0.015 [0.38]	10	DC - 4.0	1.25:1
RPC100-200-4NZ50-X	0.100 [2.54]	0.200 [5.08]	0.040 [1.02]	0.090 [2.29]	0.020 [0.51]	0.025 [0.63]	30	DC - 6.0	1.25:1
RPC250-250-4NZ50-X	0.245 [6.22]	0.245 [6.22]	0.040 [1.02]	0.130 [3.30]	0.020 [0.51]	0.040 [1.02]	100	DC - 3.0	1.25:1
RPC250-375-4NZ50-X	0.250 [6.35]	0.375 [9.53]	0.040 [1.02]	0.198 [5.03]	0.025 [0.64]	0.040 [1.02]	150	DC - 2.0	1.25:1

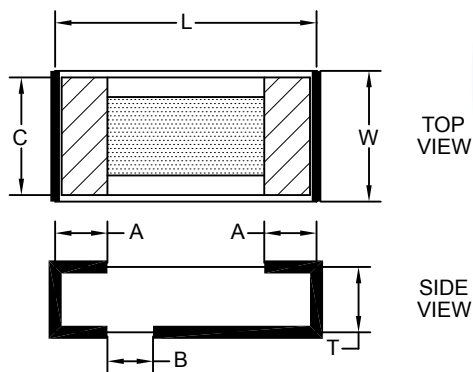

Dimensions are in inches [mm]
Tolerance: .XXX = ±0.010, .XX = ±0.015

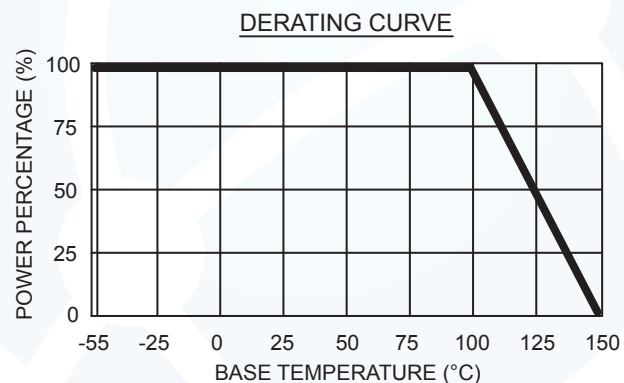

[Ordering Information on Page 51](#)

HIGH POWER CHIP TERMINATIONS

Ordering Information:

Example: RPC 50 100 -2 N T 50 -5

Series _____ ↑
 Size _____ ↑
 Thickness: _____ ↑
 No Designation: 0.010"
 2: 0.025"
 4: 0.040"
 6: 0.060"
 1: 0.135"
 Substrate: _____ ↑
 No Designation: Beryllium Oxide
 A: Alumina
 N: Aluminum Nitride
 Style: _____ ↑
 T: Termination
 Z: Double Wrap (Asymmetrical)
 Impedance (Ohms) _____ ↑
 Tolerance (±%): _____ ↑
 1:1%, 2:2%, 5:5%

Notes

TERMINATIONS TAB & COVER



General Specifications

Substrate: Beryllium Oxide or Aluminum Nitride
Resistive Film: Thick Film
Tab: Silver Plated Beryllium Oxide
Cover: Alumina

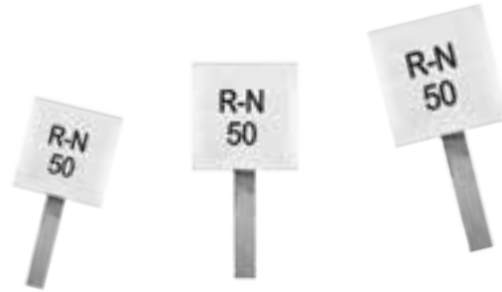

Beryllium Oxide Part Number	W inches (mm)	L inches (mm)	T (MAX)	C (±0.005) inches (mm)	A (MIN) inches (mm)	Power (W)	Frequency (GHz)	VSWR (max)
RPC50-50-T50-XC	0.050 [1.27]	0.050 [1.27]	0.058 [1.47]	0.040 [1.02]	0.125 [3.18]	8	DC – 4.0	1.25:1
RPC50-100-T50-XC	0.050 [1.27]	0.100 [2.54]	0.058 [1.47]	0.040 [1.02]	0.125 [3.18]	15	DC – 4.0	1.25:1
RPC75-150-T50-XC	0.075 [1.10]	0.150 [3.81]	0.058 [1.47]	0.040 [1.02]	0.125 [3.18]	30	DC – 6.0	1.25:1
RPC100-200-4T50-XC	0.100 [2.54]	0.200 [5.08]	0.088 [2.24]	0.040 [1.02]	0.125 [3.18]	40	DC – 6.0	1.25:1
RPC230-350-4T50-XC	0.230 [5.84]	0.350 [8.89]	0.088 [2.24]	0.040 [1.02]	0.125 [3.18]	150	DC – 4.0	1.25:1
RPC250-250-4T50-XC	0.250 [6.35]	0.250 [6.35]	0.088 [2.24]	0.060 [1.52]	0.250 [6.35]	175	DC – 2.0	1.35:1
RPC250-250-6T50-XC	0.250 [6.35]	0.250 [6.35]	0.108 [2.74]	0.060 [1.52]	0.250 [6.35]	100	DC – 2.0	1.35:1
RPC250-375-4T50-XC	0.250 [6.35]	0.375 [9.53]	0.173 [4.39]	0.250 [6.35]	0.125 [3.18]	200	DC – 2.0	1.25:1
RPC250-375-1T50-XC	0.250 [6.35]	0.375 [9.53]	0.143 [3.63]	0.250 [6.35]	0.125 [3.18]	75	DC – 1.5	1.35:1
RPC375-375-4T50-XC	0.375 [9.53]	0.375 [9.53]	0.085 [2.16]	0.060 [1.52]	0.125 [3.18]	250	DC – 2.0	1.2:1
RPC1.0-1.0-1T50-5C	1.04 [26.42]	1.00 [25.4]	0.376 [9.55]	0.250 [6.35]	0.3 [7.62]	1000	DC – 1.0	1.25:1

Aluminum Nitride Part Number	W inches (mm)	L inches (mm)	T (MAX)	C (±0.005) inches (mm)	A (MIN) inches (mm)	Power (W)	Frequency (GHz)	VSWR (max)
RPC50-100-2NT50-XC	0.050 [1.27]	0.100 [2.54]	0.073 [1.85]	0.040 [1.02]	0.125 [3.18]	8	DC – 4.0	1.25:1
RPC60-120-2NT50-XC	0.060 [1.52]	0.120 [3.05]	0.073 [1.85]	0.040 [1.02]	0.125 [3.18]	10	DC – 4.0	1.25:1
RPC100-200-4NT50-XC	0.100 [2.54]	0.200 [5.08]	0.088 [2.24]	0.040 [1.02]	0.125 [3.18]	30	DC – 6.0	1.25:1
RPC250-250-4NT50-XC	0.245 [6.22]	0.245 [6.22]	0.088 [2.24]	0.060 [1.52]	0.250 [6.35]	75	DC – 3.0	1.25:1
RPC250-375-4NT50-XC	0.250 [6.35]	0.375 [9.53]	0.143 [3.63]	0.250 [6.35]	0.125 [3.18]	125	DC – 2.0	1.25:1

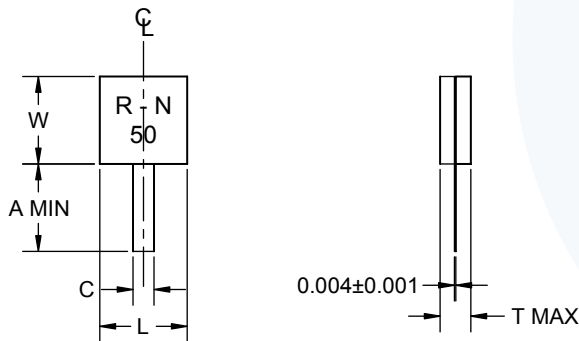

Dimensions are in inches [mm]
Tolerance: .XXX = ±0.010, .XX = ±0.015

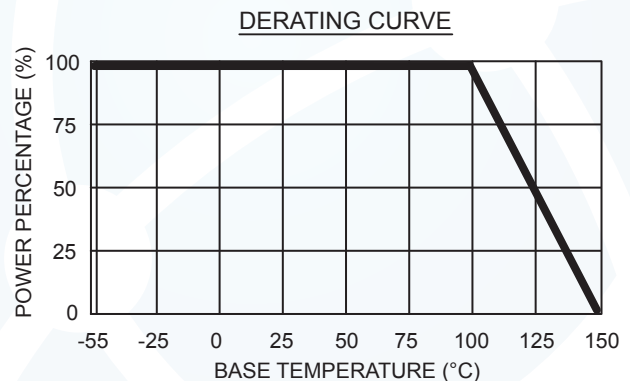

[Ordering Information on Page 53](#)

Ordering Information:

Example:

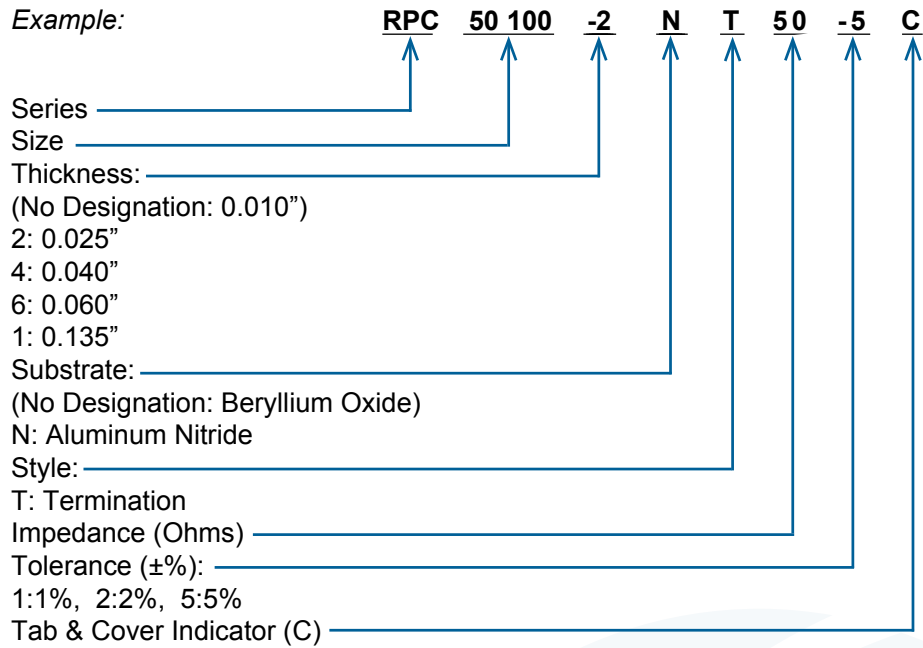

Notes

FLANGE TERMINATIONS



General Specifications

Substrate: Beryllium Oxide
Resistive Film: Thick Film
Tabs: Silver Plated Beryllium Copper
Flange: Nickel plated Copper

Cover: Alumina
Impedance: 50 Ohms
Tolerance: $\pm 1\%$, $\pm 2\%$, $\pm 5\%$
Operating Temperature: -55°C to $+150^{\circ}\text{C}$



Part Number	Power (W)	Frequency (GHz)	VSWR (max)	Figure
RPT30X-20-50-5	20	DC-8.0 GHz	1.30:1	1
RPS100T-50-5	100	DC-2.0 GHz	1.25:1	2
RPT51X-20-50-5	20	DC-1.0 GHz 1.0-8.0 GHz	1.10:1 1.25:1	3
RPT51X-30-50-5	30	DC-4.0 GHz 4.0-8.0 GHz	1.20:1 1.25:1	3
RPT51X-100-50-5	100	DC-8.0 GHz	1.25:1	3
RPT800-40-50-5	40	DC-4.0 GHz 4.0 6.0 GHz	1.25:1 1.30:1	4
RPT800-100-50-5	100	DC-6.0 GHz	1.30:1	4

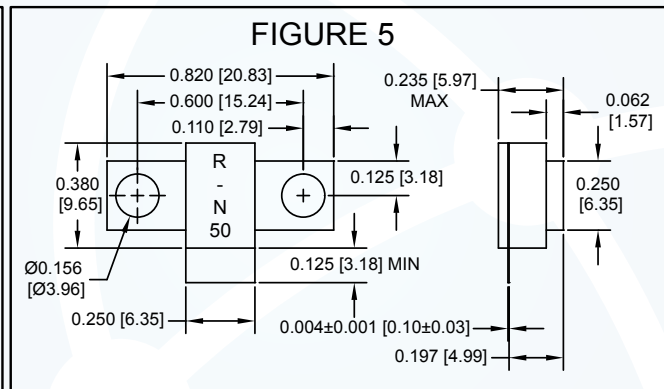
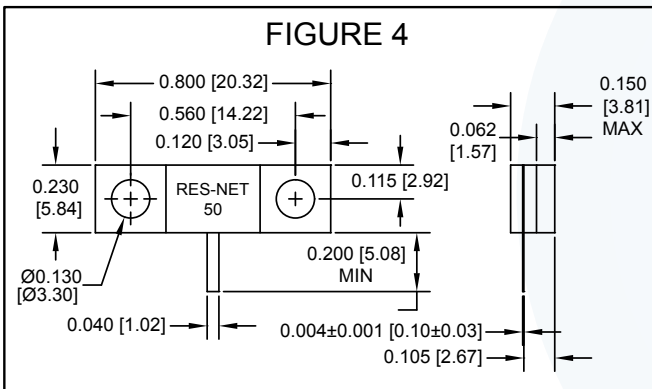
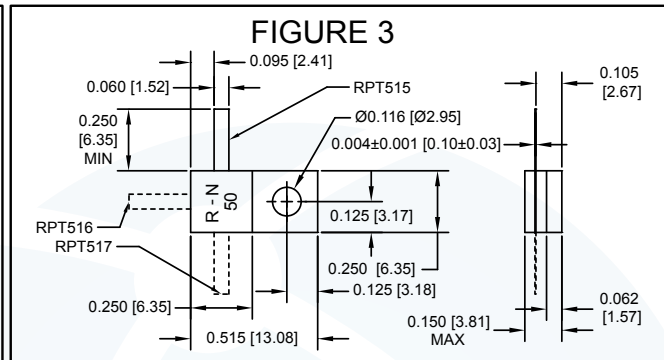
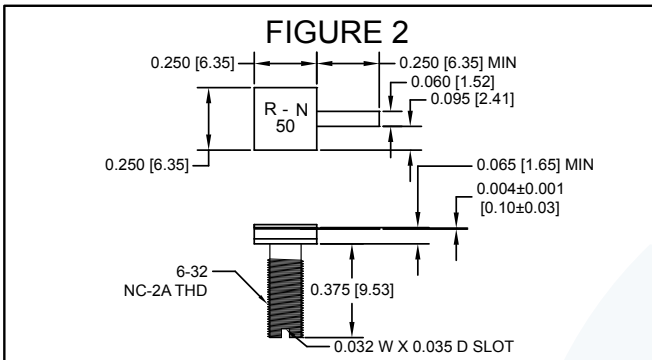
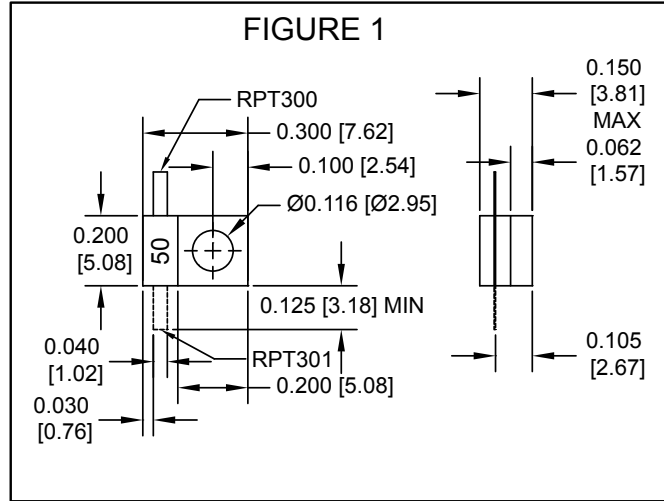

Ordering Information:

Example: **RPT 800 N 100 50 5**

Series: RPT
Length Size: 800
Substrate: N
N: ALN
No Designation for Beryllium Oxide
Power Rating: 100
Impedance: 50
Tolerance ($\pm\%$): 5
1: 1%, 2: 2%, 5: 5%

Dimensions are in inches [mm]
Tolerance: .XXX = ± 0.010
.XX = ± 0.015

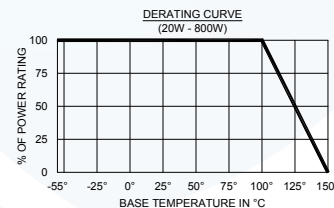

General Specifications

Substrate: Beryllium Oxide or
Aluminum Nitride

Resistive Film: Thick Film

Tabs: Silver Plated Beryllium Copper

Flange: Nickel Plated Copper

Cover: Alumina

Impedance: 50 Ohms

Tolerance: $\pm 1\%$, $\pm 2\%$, $\pm 5\%$

Operating Temperature: -55°C to $+150^{\circ}\text{C}$



Part Number	Power (W)	Frequency (GHz)	VSWR (max)	Figure
RPT975-250-50-5	250	DC-3.0	1.25:1	6
RPT1100-400-50-5	400	DC-0.5 0.5-1.0	1.25:1 1.35:1	7
RPT1100-500-50-5	500	DC-1.0 1.0-2.0	1.10:1 1.20:1	8
RPT1250-500-50-5	500	DC-1.0 1.0-2.0	1.10:1 1.20:1	9
RPT1900-800-50-5	800	DC-1.0	1.20:1	10

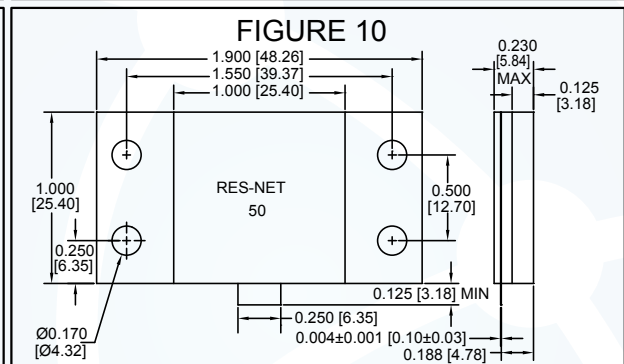
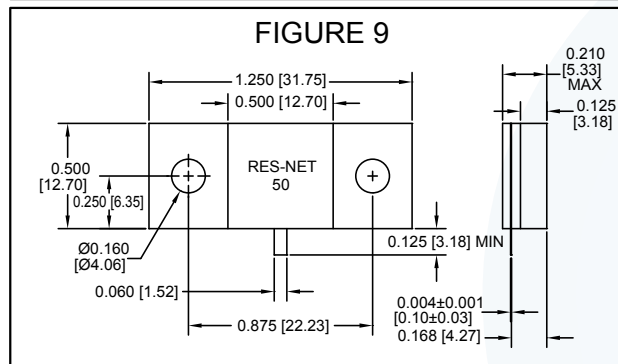
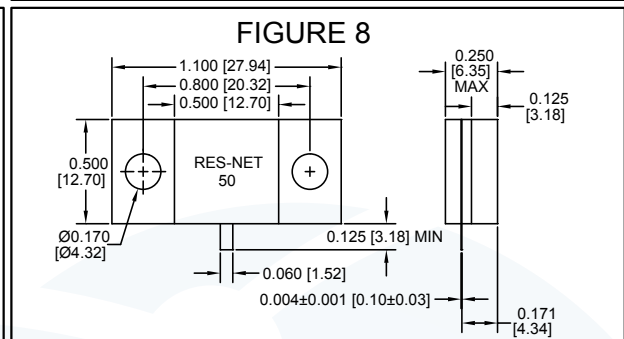
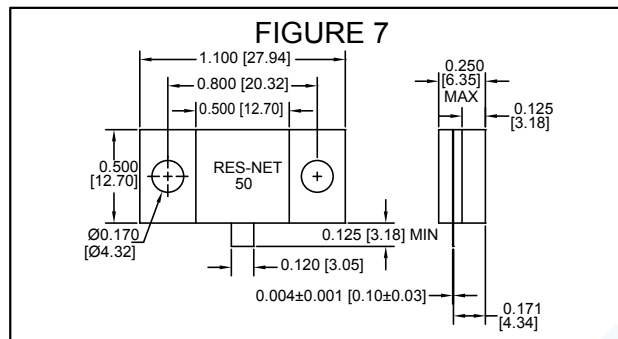
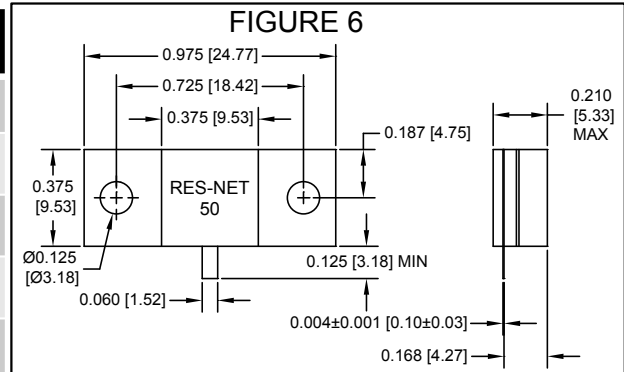

Ordering Information:

Example: **RPT 1900 N 800 50 5**

Series Model \rightarrow RPT
Flange Size \rightarrow 1900: 1.0X1.04"
Ceramic \rightarrow N: Aluminum Nitride
Standard BeO (No Designation)
Power Rating (Watts) \rightarrow 800
Impedance (Ohms) \rightarrow 50
Tolerance ($\pm\%$): \rightarrow 5

1:1%, 2:2%, 5:5%

Dimensions are in inches [mm]
Tolerance: .XXX = ± 0.010
.XX = ± 0.015

DERATING CURVE
(20W - 800W)

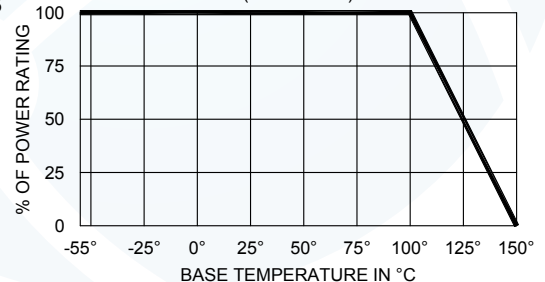

FLANGE TERMINATIONS



General Specifications

Substrate: Beryllium Oxide or Aluminum Nitride
 Resistive Film: Thick Film
 Tabs: Silver Plated Beryllium Copper
 Flange: Nickel Plated Copper

Cover: Alumina
 Impedance: 50 Ohms $\pm 5\%$
 Tolerance: $\pm 5\%$
 Temperature Range: -55°C to $+200^{\circ}\text{C}$



Part Number	Power (W)	Frequency (GHz)	VSWR (max)	Figure
RPT1900-1000-50-5	1000	DC-1.0	1.25:1	11
RPT1900N1000-50-5	1000	DC-1.0	1.25:1	11
RPT1900-1200-50-5	1200	DC-1.0	1.25:1	12

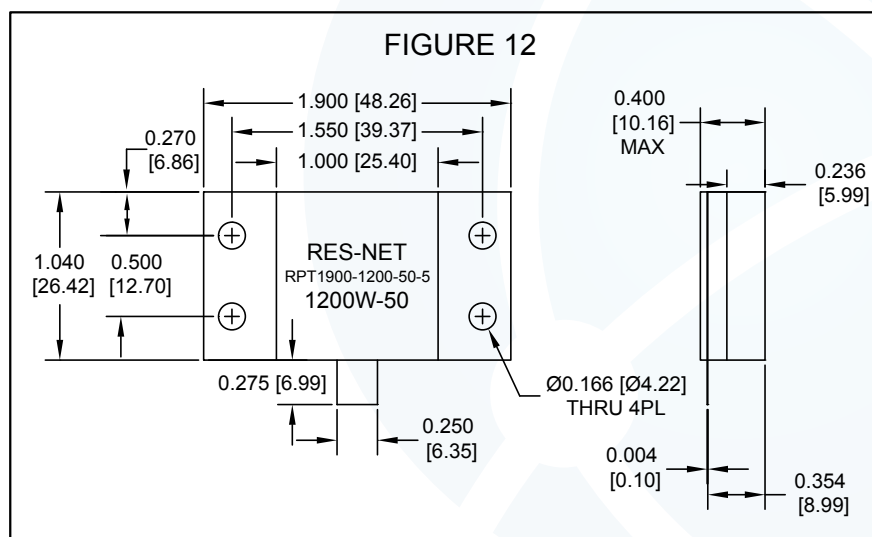
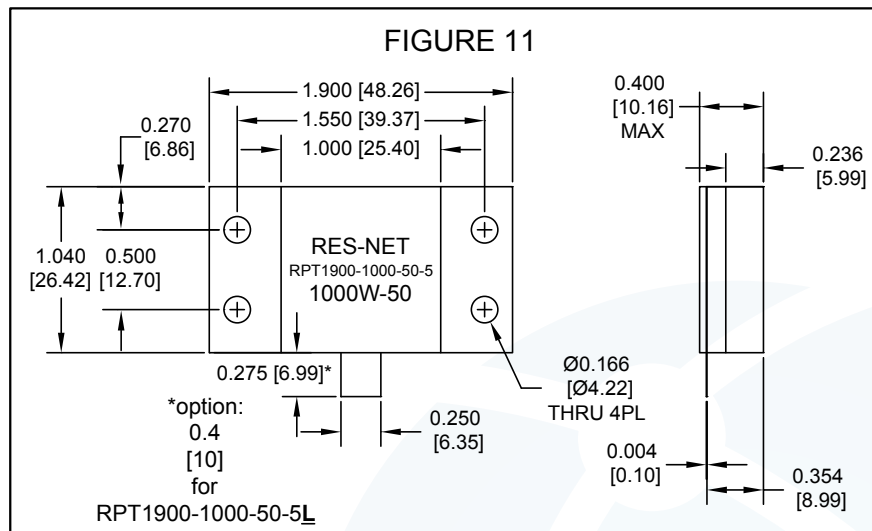
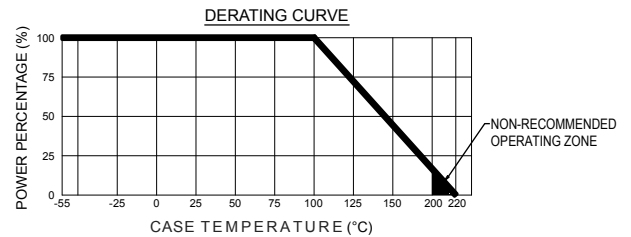

Dimensions are in inches [mm],
 Tolerance: .XXX = ± 0.010 ,
 XX = ± 0.015

[Ordering Information on Page 57](#)



General Specifications

Substrate: Beryllium Oxide
Resistive Film: Thick Film
Tabs: Silver Plated Beryllium Copper
Flange: Nickel Plated Copper

Cover: Alumina
Impedance: 50 Ohms
Tolerance: $\pm 5\%$
Operating Temperature: -55°C to $+150^{\circ}\text{C}$



Part Number	Power (W)	Frequency (GHz)	VSWR (max)
RPT1900-1500-50-5	1500	DC-1.5	1.15:1

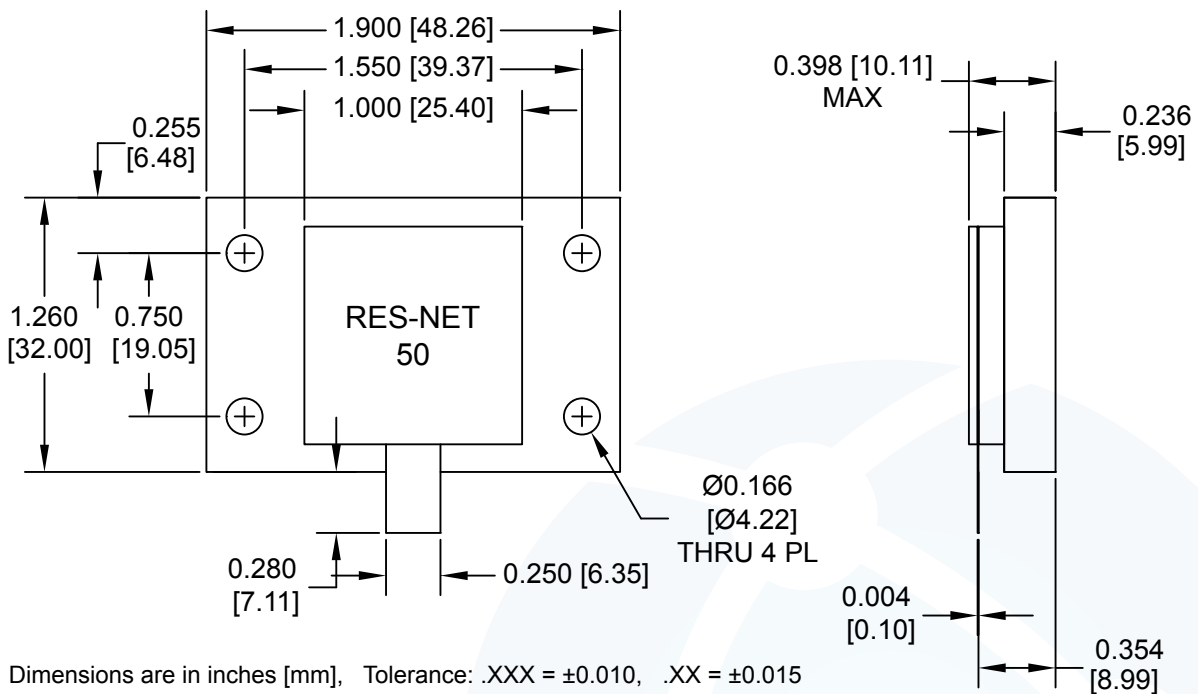

Ordering Information:

Example:

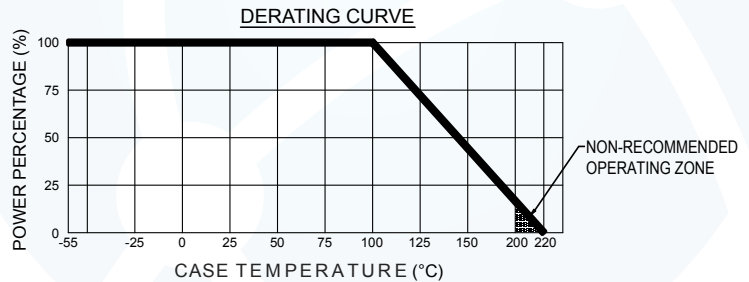
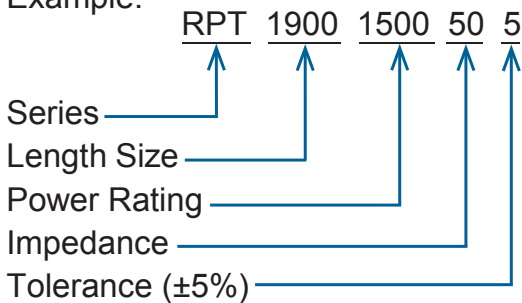

STRIPLINE FLANGE TERMINATIONS



General Specifications

Substrate: Alumina or Beryllium Oxide
 Resistive Material: Thin Film
 Contacts: Gold Plated Beryllium Copper or Brass
 Housing: Nickel Plated Aluminum or Brass
 Impedance: 50 Ohms
 Tolerance: $\pm 5\%$
 Power Rating: 1 Watt
 Temperature range: -55°C to $+150^{\circ}\text{C}$



Part Number	Frequency (GHz)	VSWR (max)	Mechanical Outline
RFT375-3	DC-4.0 4.0-8.0 8.0-18	1.15:1 1.20:1 1.35:1	
RFT375-X	DC-4.0 4.0-8.0 8.0-18	1.15:1 1.20:1 1.35:1	

Dimensions are in inches [mm], Tolerance: .XXX = ± 0.010 , .XX = ± 0.015

Ordering Information:

Example:

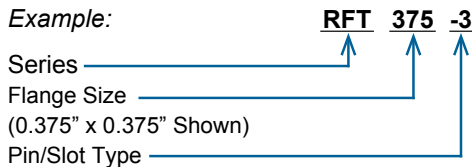

X (Connector Type)	A Dimension inches (mm)
4	0.014" [0.36]
5	0.020" [0.51]
6	0.028" [0.71]

DERATING CURVE

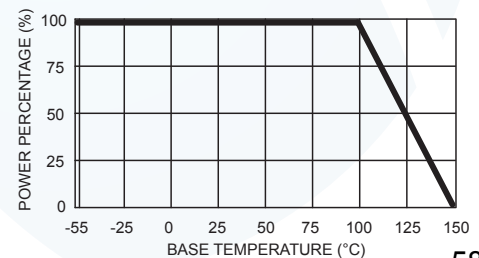

STRIPLINE FLANGE TERMINATIONS

General Specifications

Substrate: Alumina or Beryllium Oxide
 Resistive Material: Thin Film
 Contacts: Gold Plated Beryllium Copper or Brass
 Housing: Nickel Plated Aluminum or Brass
 Impedance: 50 Ohms
 Tolerance: $\pm 5\%$
 Temperature range: -55°C to $+150^{\circ}\text{C}$

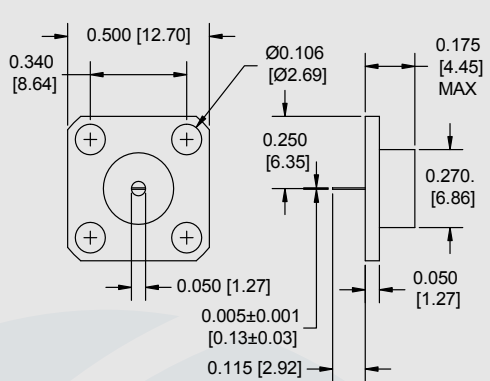
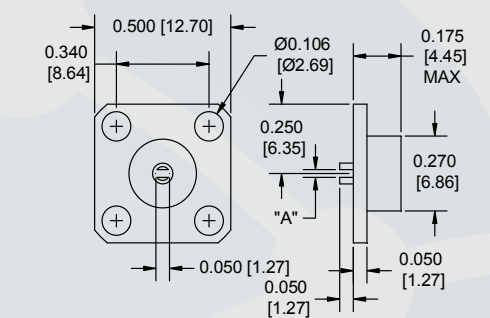

Part Number	Frequency (GHz) VSWR (MAX)					Power (W)	Mechanical Outline
	DC -2.0	2.0 -4.0	4.0 -8.0	8.0 -12.0	12.0 -18.0		
RFT502-10	1.10:1					10	
RFT504-10	1.10:1	1.10:1					
RFT508-10	1.10:1	1.10:1	1.20:1				
RFT512-10	1.10:1	1.10:1	1.20:1	1.30:1	NA		
RFT518-10	1.10:1	1.10:1	1.20:1	1.30:1	1.35:1		
RFT502-X	1.10:1					10	
RFT504-X	1.10:1	1.10:1					
RFT508-X	1.10:1	1.10:1	1.20:1				
RFT518-X	1.10:1	1.10:1	1.20:1	1.30:1	1.35:1		

Dimensions are in inches [mm], Tolerance: .XXX = ± 0.010 , .XX = ± 0.015

Ordering Information:

Example: **RFT 5 18 -6**

Series ———— ↑
 Flange Size ———— ↑
 (0.5" x 0.5" Shown)
 MAX Frequency (GHz) ———— ↑
 Pin/Slot Type ———— ↑

X (Connector Type)	A Dimension inches (mm)
6	0.028" [0.71]
7	0.032" [0.81]
8	0.014" [0.36]
9	0.020" [0.51]

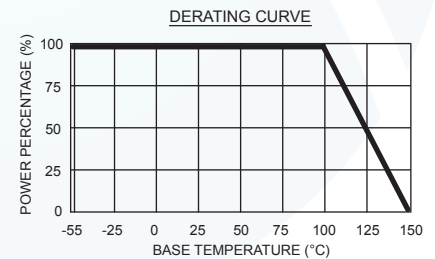

STRIPLINE FLANGE TERMINATIONS



General Specifications

Substrate: Alumina or Beryllium Oxide
 Resistive Material: Thin Film
 Contacts: Gold Plated Beryllium Copper or Brass
 Housing: Nickel Plated Aluminum or Brass
 Impedance: 50 Ohms
 Tolerance: $\pm 5\%$
 Temperature range: -55°C to $+150^{\circ}\text{C}$



Part Number	Frequency (GHz) VSWR (max)					Power (W)	Mechanical Outline
	DC - 2.0	2.0 - 4.0	4.0 - 8.0	8.0 - 12.0	12.0 - 18.0		
RFT502-1	1.10:1					20	
RFT504-1	1.10:1	1.10:1					
RFT508-1	1.10:1	1.10:1	1.15:1				
RFT512-1	1.0:1	1.10:1	1.15:1	1.25:1			
RFT518-1	1.0:1	1.10:1	1.15:1	1.25:1	1.30		
RFT502-2	1.10:1					20	
RFT504-2	1.10:1	1.15:1					
RFT508-2	1.10:1	1.15:1	1.20:1				
RFT512-2	1.10:1	1.15:1	1.20:1	1.30:1			
RFT518-2	1.10:1	1.15:1	1.20:1	1.30:1	1.30:1		

Dimensions are in inches [mm], Tolerance: .XXX = ± 0.010 , .XX = ± 0.015

Ordering Information:

Example: **RFT 5 18 -2**

Series \rightarrow RFT
 Flange Size (0.5" x 0.5") \rightarrow 5
 MAX Frequency (GHz) \rightarrow 18
 Pin/Slot Type \rightarrow -2

DERATING CURVE

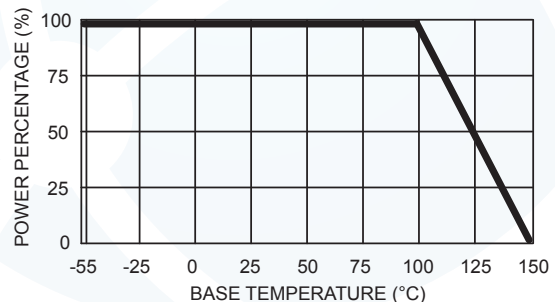

STRIPLINE FLANGE TERMINATIONS

General Specifications

Substrate: Beryllium Oxide
 Resistive Material: Thin Film
 Contacts: Gold Plated Beryllium Copper or Brass
 Housing: Nickel Plated Aluminum or Brass
 Impedance: 50 Ohms
 Tolerance: $\pm 5\%$
 Temperature range: -55°C to $+150^{\circ}\text{C}$

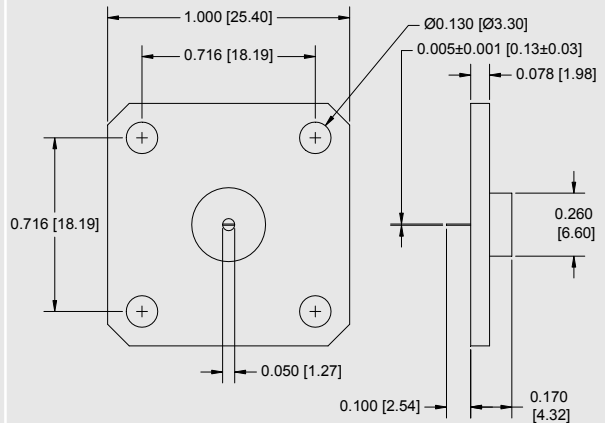

Part Number	Frequency (GHz) VSWR (MAX)				Power (W)	Mechanical Outline
	DC – 2.0	2.0 – 4.0	4.0- 8.0	8.0- 18.0		
RFT1002-1	1.10:1				10	
RFT1004-1	1.10:1	1.15:1				
RFT1008-1	1.10:1	1.15:1	1.20:1			
RFT1018-1	1.10:1	1.15:1	1.20:1	1.35:1		

Dimensions are in inches [mm], Tolerance: .XXX = ± 0.010 , .XX = ± 0.015

Ordering Information:

Example: **RFT 5 18 -1**

Series ———— **RFT**
 Flange Size ———— **5**
 (1.0" x 1.0")
 MAX Frequency (GHz) ———— **18**
 Pin/Slot Type ———— **-1**

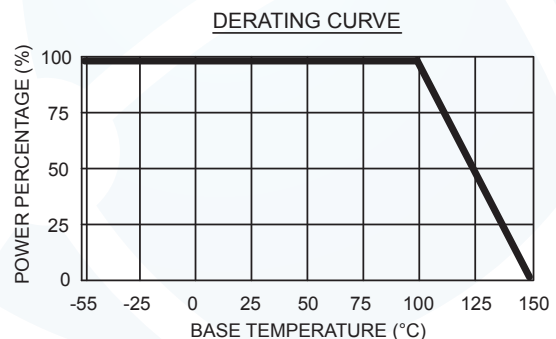

COAXIAL TERMINATIONS CONDUCTION COOLED K CONNECTOR (2.92mm)



General Specifications

Impedance: 50 Ohms
 Temperature Range: -55°C to +150°C
 Housing: Passivated Stainless Steel (IAW ASTM-A484 & ASTM-A582, Alloy 303, Cond. A)
 Conductor: Gold Plated IAW MIL-PRF-39012 +100°C.
 Temperature Range: -55°C to +150°C
 Housing: Black Anodized where applicable.



Part Number	Frequency (GHz)	VSWR (max)	Power (W)
RCX8KM2	DC-40.0	1.25:1	2

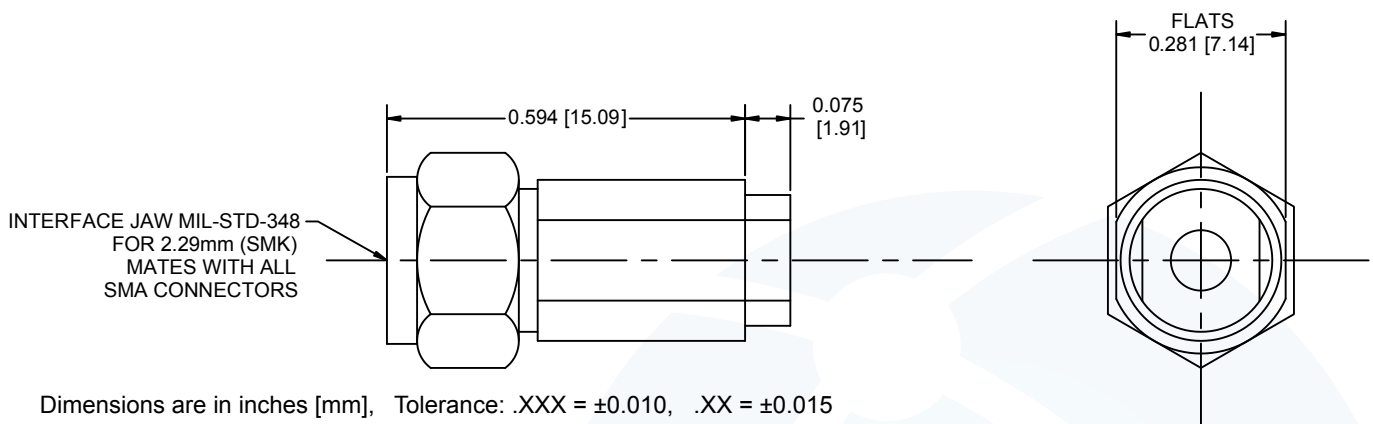

Ordering Information:

Example: **RCX 8 K M 2**

Series ———— ↑
 Frequency: ———— ↑
 8: DC-40 GHz (VSWR: 1.25:1)
 Connector Type: ———— ↑
 K: 2.92mm
 Gender ———— ↑
 M: Male
 Power (W) ———— ↑

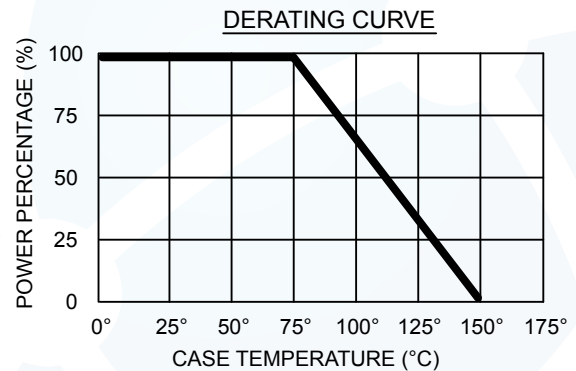

COAXIAL TERMINATIONS CONDUCTION COOLED SMA CONNECTORS

General Specifications

Impedance: 50 Ohms
 Temperature Range: -55°C to +150°C
 Housing: Nickel Plated Stainless Steel (Gold plated available upon request)
 Connector Nut: Passivated Stainless Steel
 Connector Pin: Gold Plated Brass +100°C.
 Temperature Range: -55°C to +150°C
 Housing: Black Anodized where applicable.



Part Number	Frequency GHz	VSWR (max)	Power (W)	Mechanical Outline
RCX1SM	DC-12.0	1.25:1	1	
RCX2SM	DC-18.0	1.25:1		
RCX3SM	DC-12.0	1.15:1		
RCX4SM	DC-20.0	1.15:1		
RCX5SM	DC-8.0	1.15:1		
RCX6SM	DC-4.0	1.25:1		
RCX7SM	DC-26.5	1.35:1		

Dimensions are in inches [mm], Tolerance: .XXX = ±0.010, .XX = ±0.015

Ordering Information:

Example: **RCX 6 S M 2 B**

Series ———— ↑

Frequency: ———— ↑

1:DC-12.0 GHz (VSWR: 1.25:1)
 2:DC-18.0 GHz (VSWR: 1.25:1)
 3:DC-12.0 GHz (VSWR: 1.15:1)
 4:DC-2.0 GHz (VSWR: 1.15:1)
 5:DC-8.0 GHz (VSWR: 1.15:1)
 6:DC-4.0 GHz (VSWR: 1.25:1)

Connector Type: ———— ↑

S: SMA

Gender: ———— ↑

M: Male

Power: ———— ↑

Blank: 1 Watt
 2: 2 Watts

Standard: Blank ———— ↑

B: Ball and Chain

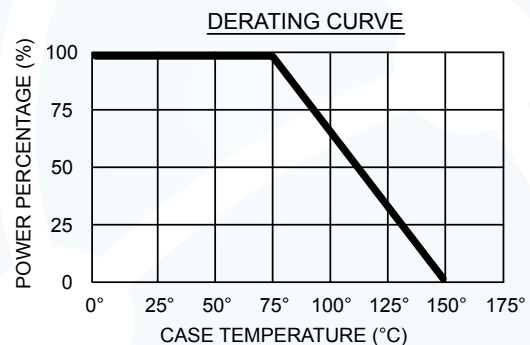

COAXIAL TERMINATIONS CONDUCTION COOLED SMA CONNECTORS



General Specifications

Impedance: 50 Ohms
 Temperature Range: -55°C to +150°C
 Housing: Nickel Plated Stainless Steel (Gold plated available upon request)
 Connector Nut: Passivated Stainless Steel
 Connector Pin: Gold Plated Brass 55°C to +100°C.
 Temperature Range: -55°C to +150°C
 Housing: Black Anodized where applicable.



Part Number	Frequency GHz	VSWR (max)	Power (W)	Mechanical Outline
RCX1SM2	DC-12.0	1.25:1	2	
RCX2SM2	DC-18.0	1.25:1		
RCX3SM2	DC-12.0	1.15:1		
RCX4SM2	DC-2.0	1.15:1		
RCX5SM2	DC-8.0	1.15:1		
RCX6SM2	DC-4.0	1.25:1		

Ordering Information:

Example: **RCX 6 S M 2 B**

Series ↑ ↑

Frequency: ↑ ↑

1:DC-12.0 GHz (VSWR: 1.25:1)
 2:DC-18.0 GHz (VSWR: 1.25:1)
 3:DC-12.0 GHz (VSWR: 1.15:1)
 4:DC-2.0 GHz (VSWR: 1.15:1)
 5:DC-8.0 GHz (VSWR: 1.15:1)
 6:DC-4.0 GHz (VSWR: 1.25:1)

Connector Type: ↑ ↑

S: SMA

Gender: ↑ ↑

M: Male

Power: ↑ ↑

Blank: 1 Watt

2: 2 Watts

Standard: Blank ↑ ↑

B: Ball and Chain

*ADD "B" AT END OF PART NUMBER FOR BALL & CHAIN

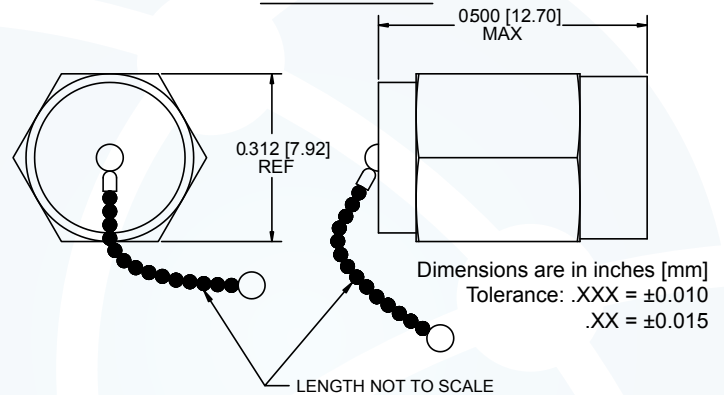

DERATING CURVE

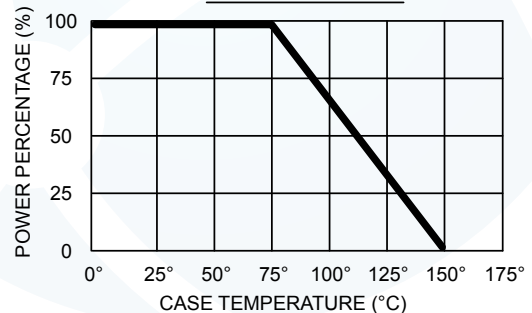

COAXIAL TERMINATIONS

CONDUCTION COOLED BNC, TNC, & N-TYPE CONNECTORS

General Specifications

Impedance: 50 Ohms
Housing: Nickel Plated Brass
Mechanical Tolerance: ± 0.010 inch unless otherwise specified
Temperature Range: -55°C to $+150^{\circ}\text{C}$
Temperature Coefficient: ± 100 PPM/ $^{\circ}\text{C}$ maximum
from -55°C to $+100^{\circ}\text{C}$. $+100^{\circ}\text{C}$.
Temperature Range: -55°C to $+150^{\circ}\text{C}$
Housing: Black Anodized where applicable.

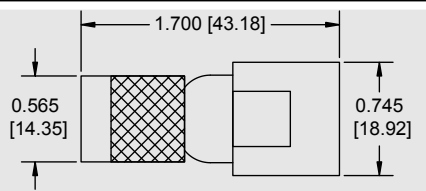
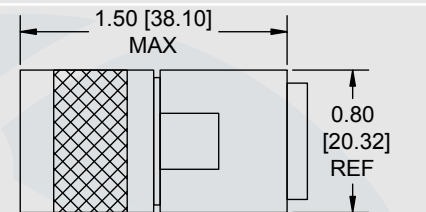

Part Number	Connector Type	Frequency (GHz)	VSWR (max)	Power (W)	Mechanical Outline
RCX6BX	BNC	DC-2.0	1.10:1	2	
RCX7BX	BNC	DC-4.0	1.20:1	2	
RCX5TX	TNC	DC-8.0	1.25:1	5	
RCX6TX	TNC	DC-4.0	1.15:1	5	
RCX1NX	N-TYPE	DC-12.0	1.25:1	5	
RCX3NX	N-TYPE	DC-12.0	1.25:1	5	
RCX5NX	N-TYPE	DC-8.0	1.25:1	5	
RCX6NX	N-TYPE	DC-4.0	1.15:1	5	

Dimensions are in inches [mm], Tolerance: .XXX = ± 0.010 , .XX = ± 0.015

Ordering Information:

Example: **RCX 6 B X**

Series \rightarrow RCX
Frequency Indicator \rightarrow 6
Connector Type \rightarrow B
Gender \rightarrow X

B: BNC
T: TNC
N: N-Type
M: Male
F: Female

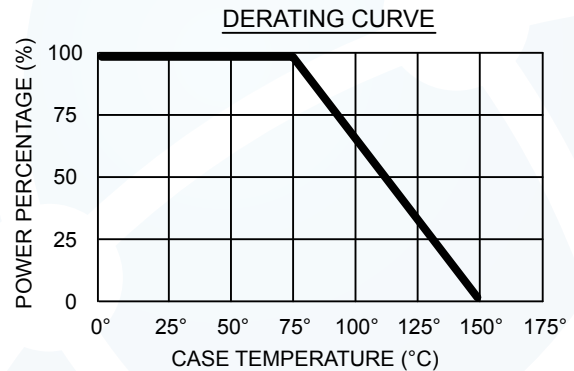

COAXIAL TERMINATIONS CONDUCTION COOLED SMA CONNECTORS CONNECTORS



General Specifications

Impedance: 50 Ohms
 Temperature Coefficient: ± 100 PPM/ $^{\circ}\text{C}$
 from -55°C to $+100^{\circ}\text{C}$.
 Temperature Range: -55°C to $+150^{\circ}\text{C}$
 Housing: Nickel Plated Copper
 Connector Body: Conforms to MIL-C-39012



Part Number	Connector Type	Frequency (GHz)	VSWR (max)	Power (W)	Mechanical Outline
RCX-SX15A	SMA	DC-4.0 4.0-8.0 8.0-12.0	1.15:1 1.25:1 1.30:1	15	<p>Male</p>
RCX-SX15B	SMA	DC-4.0 4.0-8.0 8.0-12.0	1.25:1 1.30:1 1.35:1		
RCX-SX15C	SMA	DC-8.0	1.25:1	15	<p>Female</p>
RCX-SX15D	SMA				
RCX-SX20A	SMA	DC-1.0 1.0-3.0	1.15:1 1.25:1	20	<p>Male</p>
RCX-SX20B	SMA	DC-3.0 3.0-5.0	1.25:1 1.35:1		
					<p>Female</p>

[Ordering Information on page 68](#)

Dimensions are in inches [mm], Tolerance: .XXX = ± 0.010 , .XX = ± 0.015



COAXIAL TERMINATIONS CONDUCTION COOLED SMA CONNECTORS

General Specifications

Impedance: 50 Ohms

Temperature Coefficient: ± 100 PPM/ $^{\circ}\text{C}$ maximum from
-55 $^{\circ}\text{C}$ to +100 $^{\circ}\text{C}$.

Temperature Range: -55 $^{\circ}\text{C}$ to +150 $^{\circ}\text{C}$

Housing: Nickel Plated Copper

Connector Body: Conforms to MIL-C-39012

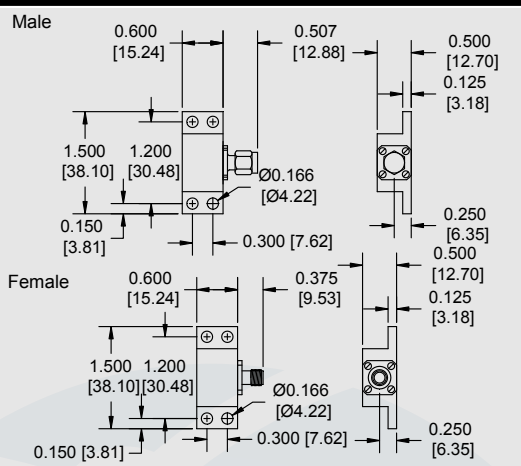
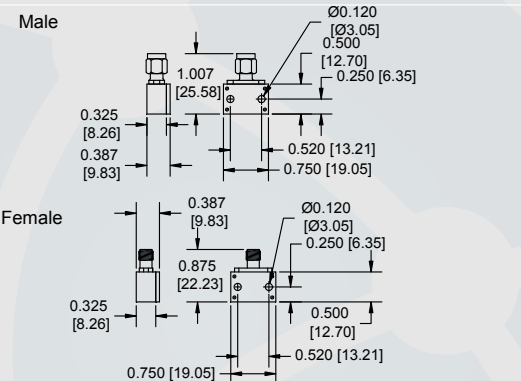

Part Number	Connector Type	Frequency (GHz)	VSWR (max)	Power (W)	Mechanical Outline
RCX-SX30A	SMA	DC-4.0 4.0-8.0 8.0-12.0	1.20:1 1.25:1 1.30:1	30	
RCX-SX30B	SMA	DC-8.0 8.0-12.0 12.0-18.0	1.25:1 1.30:1 1.35:1		
RCX-SX30C	SMA	DC-8.0	1.30:1		
RCX-SX30D	SMA	DC-4.0	1.20:1		
RCX-SX51A	SMA	DC-2.0 2.0-4.0	1.15:1 1.25:1	50	
RCX-SX52B	SMA	DC-2.0	1.15:1		

Dimensions are in inches [mm]
Tolerance: .XXX = ± 0.010
.XX = ± 0.015

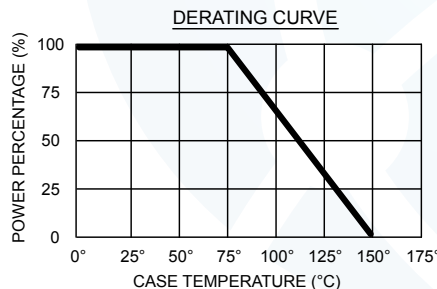

[Ordering Information](#)
on Page 68

COAXIAL TERMINATIONS CONDUCTION COOLED SMA CONNECTORS CONNECTORS



General Specifications

Impedance: 50 Ohms
 Mechanical Tolerance: ± 0.010 inch unless otherwise specified
 Temperature Coefficient: ± 100 PPM/ $^{\circ}\text{C}$ maximum from -55°C to $+100^{\circ}\text{C}$.
 Temperature Range: -55°C to $+150^{\circ}\text{C}$
 Housing: Nickel Plated Copper
 Resistive Element: Proprietary film
 Connector Body: Conforms to MIL-C-39012



Part Number	Connector Type	Frequency (GHz)	VSWR (max)	Power (W)	Mechanical Outline
RCX50SX	SMA	DC-3.0 3.0-6.0	1.15:1 1.25:1	50	Male
RCX100SX	SMA			100	Female

Dimensions are in inches [mm], Tolerance: .XXX = ± 0.010 , .XX = ± 0.015

Ordering Information:

Example: **RCX 100 S X**

Series \rightarrow RCX
 Power (W) \rightarrow 100
 Connector Type \rightarrow S
 Gender \rightarrow X

S: SMA
 T: TNC
 N: N-Type
 M: Male
 F: Female

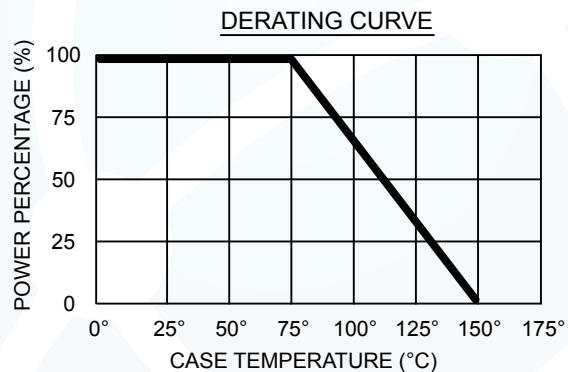

COAXIAL TERMINATIONS CONDUCTION COOLED SMA CONNECTORS

General Specifications

Impedance: 50 Ohms
 Mechanical Tolerance: ± 0.010 inch unless otherwise specified
 Temperature Coefficient: ± 100 PPM/ $^{\circ}$ C maximum from -55° C to $+100^{\circ}$ C.
 Temperature Range: -55° C to $+150^{\circ}$ C
 Housing: Nickel Plated Copper
 Resistive Element: Proprietary film
 Connector Body: Conforms to MIL-C-39012

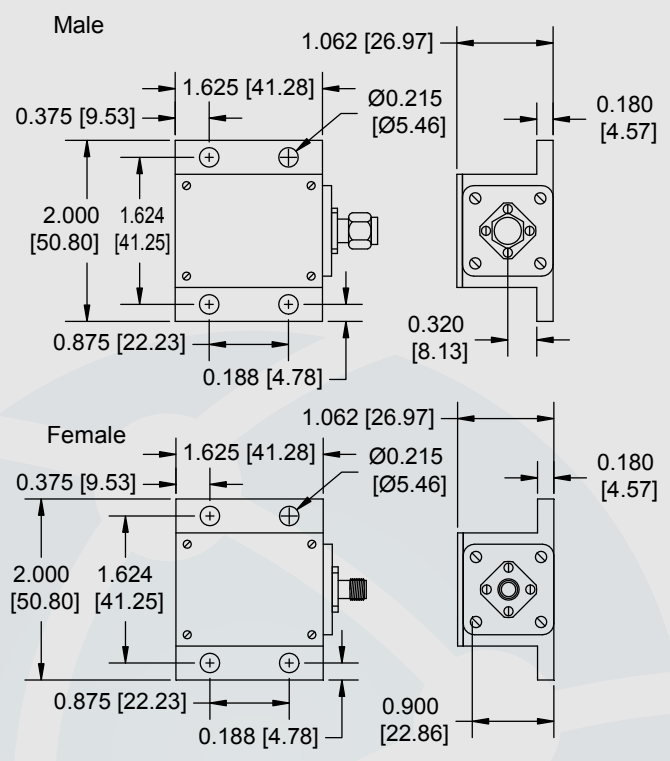

Part Number	Connector Type	Frequency (GHz)	VSWR (max)	Power (W)	Mechanical Outline
RCX150SX	SMA	DC-3.0 3.0-6.0	1.20:1 1.30:1	150 W	
RCX-250SX	SMA			250 W	

Dimensions are in inches [mm], Tolerance: .XXX = ± 0.010 , .XX = ± 0.015

Ordering Information:

Example: **RCX 250 S X**

Series \rightarrow RCX
 Power (W) \rightarrow 250
 Connector Type \rightarrow S
 Gender \rightarrow X

S: SMA
 T: TNC
 N: N-Type
 M: Male
 F: Female

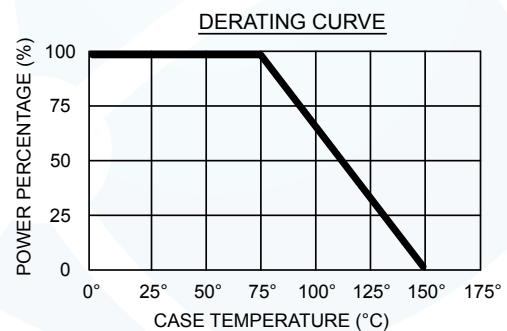

COAXIAL TERMINATIONS CONDUCTION COOLED TNC, & N-TYPE CONNECTORS



General Specifications

Impedance: 50 Ohms
 Mechanical Tolerance: ± 0.010 inch unless otherwise specified
 Temperature Coefficient: ± 100 PPM/ $^{\circ}\text{C}$ maximum from -55°C to $+100^{\circ}\text{C}$.
 Temperature Range: -55°C to $+150^{\circ}\text{C}$
 Housing: Nickel Plated Copper



Part Number	Connector Type	Frequency (GHz)	VSWR (max)	Power (W)	Mechanical Outline
RCX100TX	TNC	DC-3.0	1.25:1	100	
RCX150TX	TNC	DC-1.0 1.0-2.0 2.0-3.0	1.10:1 1.15:1 1.30:1	150	
RCX250TX	TNC				
RCX250NX	N-TYPE	DC-5.0	1.25:1	250	

Ordering Information:

Example: **RCX 100 T X**

Series ———— ↑
 Power (W) ———— ↑
 Connector Type ———— ↑
 B: TNC
 N: N-Type
 Gender ———— ↑
 M: Male
 F: Female

Dimensions are in inches [mm], Tolerance: .XXX = ± 0.010 , .XX = ± 0.015

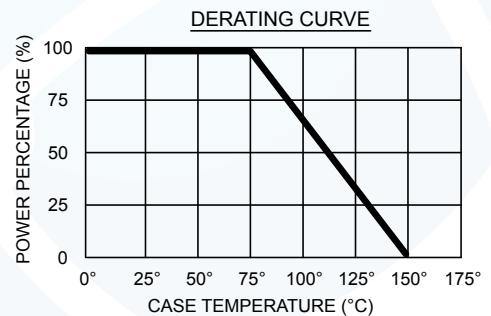

COAXIAL TERMINATIONS CONVECTION COOLED

General Specifications

Substrate: Ceramic Rod
 Resistive Film: Thin Film
 Connectors: Passivated Steel / Gold Plated Pin
 Power Rating: 5 Watts
 Temperature Range: -55°C to +150°C



Part Number	Connector Type	Frequency (GHz)	VSWR (max)	Mechanical Outline
RCX-SX5A	SMA	DC-4.0 4.0 to 8.0 8.0 to 12.0	1.15:1 1.25:1 1.30:1	
RCX-SX5B	SMA	DC-8.0 8.0 to 12.0 12.0 to 18.0	1.20:1 1.25:1 1.30:1	
RCX-SX5C	SMA	DC-8.0	1.20:1	
RCX-SX5D	SMA	DC-4.0	1.15:1	

Dimensions are in inches [mm], Tolerance: .XXX = ±0.010, .XX = ±0.015

Ordering Information:

Example: **RCX -S X 5 A**

Series ↑

Connector Type ↑

S: SMA

Gender ↑

M: Male

F: Female

Power (W) ↑

Frequency Range Indicator ↑

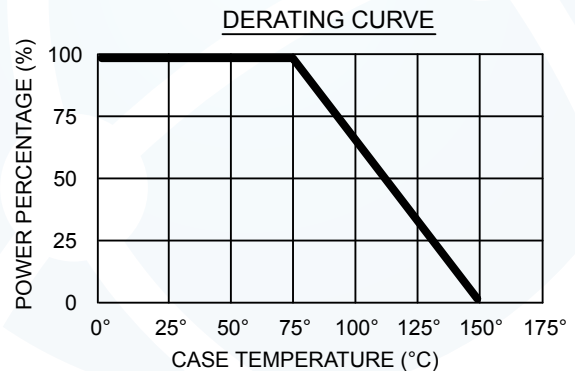

COAXIAL TERMINATIONS CONVECTION COOLED



General Specifications

Substrate: Beryllium Oxide
Resistive Material: Thick Film
Connector Body: N-Type, "TNC", "SMA", and "BNC"
Connector Interface: Conforms to MIL-C-39012
Housing: Black Anodized Aluminum
Heat Spreader: Copper
Impedance: 50 Ohms



Part Number	Connector	Power (W)	Frequency (GHz)	VSWR (max)	Mechanical Outline
RFT15DXB	SMA	15	DC-4.0 4.0-8.0 8.0-12.0	1.20:1 1.25:1 1.30:1	
RFT15SXC	SMA	15	DC-8.0 DC-8.0	1.20:1 1.20:1	
RFT15SXD	SMA	15	DC-4.0 DC-4.0	1.15:1 1.15:1	
RFT25SXA	SMA	25	DC-4.0 4.0-8.0 8.0-12.0	1.15:1 1.25:1 1.30:1	
RFT25SXB	SMA		DC-4.0 4.0-8.0 8.0-18.0	1.20:1 1.25:1 1.30:1	
RFT25SXC	SMA		DC-8.0 DC-8.0	1.20:1	
RFT25SXD	SMA		DC-4.0 DC-4.0	1.15:1	

Dimensions are in inches [mm], Tolerance: .XXX = ±0.010, .XX = ±0.015

Ordering Information:

Example: **RFT 25 S X A**

Series ——— RFT
Power (W) ——— 25
Connector Type ——— S
Gender ——— X
Frequency Range Indicator ——— A

B: BNC
N: N-Type
T: TNC
S: SMA
M: Male
F: Female

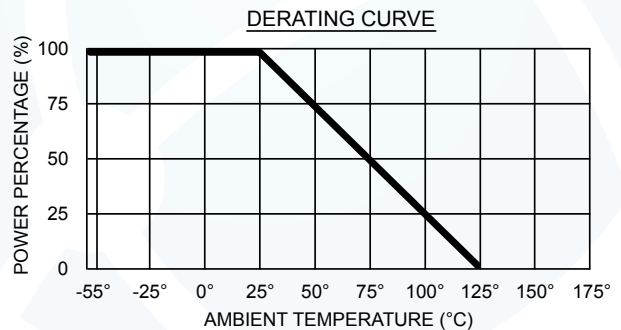

COAXIAL TERMINATIONS CONVECTION COOLED

General Specifications

Substrate: Beryllium Oxide
 Resistive Material: Thick Film
 Connector Body: N-Type, "TNC", "SMA", and "BNC"
 Connector Interface: Conforms to MIL-C-39012
 Housing: Black Anodized Aluminum
 Heat Spreader: Copper
 Impedance: 50 Ohms

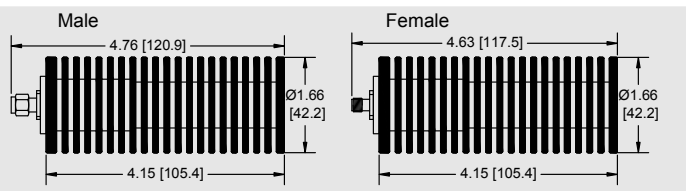
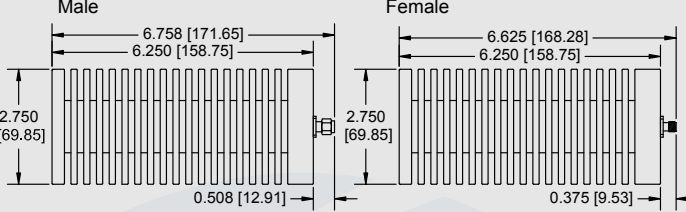
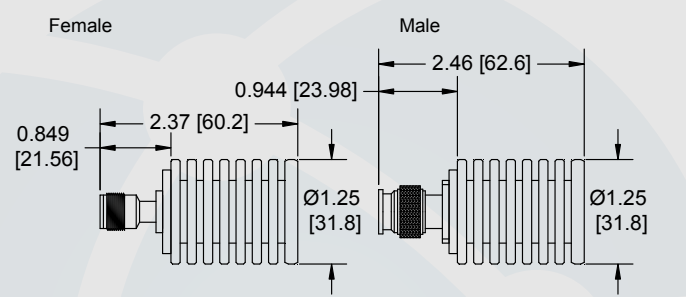

Part Number	Connector	Power (W)	Frequency (GHz)	VSWR (max)	Mechanical Outline
RFT50SXE RFT50SXD RFT50SXC	SMA	50	DC-2.0 DC-4.0 DC-8.0	1.10:1 1.15:1 1.20:1	
RFT100SXE RFT100SXD	SMA	100	DC-4.0 DC-8.0	1.15:1 1.20:1	
RFT10TXD RFT10TXC	TNC	10	DC-4.0 DC-8.0	1.15:1 1.20:1	
RFT15TXD RFT15TXC	TNC	15	DC-4.0 DC-8.0	1.15:1 1.20:1	
RFT25TXD RFT25TXC	TNC	25	DC-4.0 DC-8.0	1.15:1 1.20:1	

Dimensions are in inches [mm], Tolerance: .XXX = ±0.010, .XX = ±0.015

Ordering Information:

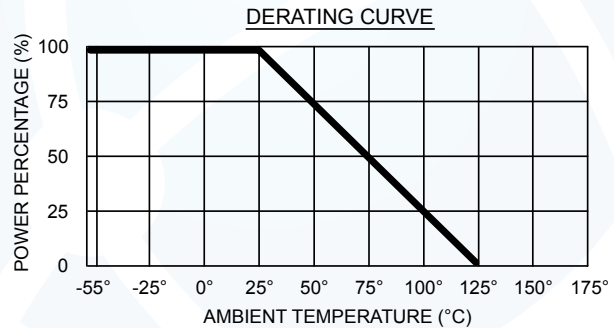
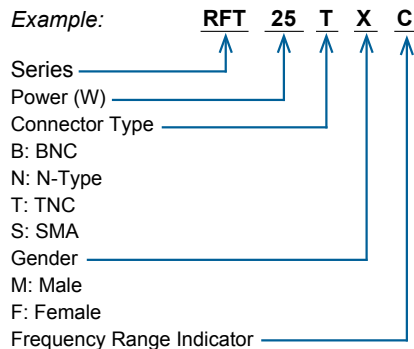

COAXIAL TERMINATIONS CONVECTION COOLED



General Specifications

Substrate: Beryllium Oxide
Resistive Material: Thick Film
Connector Body: N-Type, "TNC", "SMA", and "BNC"
Connector Interface: Conforms to MIL-C-39012
Housing: Black Anodized Aluminum
Heat Spreader: Copper
Impedance: 50 Ohms



Part Number	Connector	Power (W)	Frequency (GHz)	VSWR (max)	Mechanical Outline
RFT50TXD RFT50TXC	TNC	50	DC-2.0 DC-4.0	1.10:1 1.15:1	
RFT100TXF RFT100TXE RFT100TXD	TNC	100	DC-1.0 DC-2.0 DC-4.0	1.10:1 1.15:1 1.20:1	
RFT10BXE RFT10BXD	BNC	10	DC-2.0 DC-4.0	1.10:1 1.15:1	
RFT15BXE RFT15BXD	BNC	15	DC-2.0 DC-4.0	1.10:1 1.15:1	
RFT25BXF RFT25BXE RFT25BXD	BNC	25	DC-1.0 DC-2.0 DC-4.0	1.10:1 1.15:1 1.20:1	
RFT50BXE RFT50BXD	BNC	50	DC-2.0 DC-4.0	1.15:1 1.25:1	
RFT100BXE RFT100BXD	BNC	100	DC-2.0 DC-4.0	1.15:1 1.25:1	

Ordering Information on page 75

Dimensions are in inches [mm], Tolerance: .XXX = ±0.010, .XX = ±0.015

COAXIAL TERMINATIONS CONVECTION COOLED

General Specifications

Substrate: Beryllium Oxide
 Resistive Material: Thick Film
 Connector Body: N-Type, "SMA", and "BNC"
 Connector Interface: Conforms to MIL-C-39012
 Housing: Black Anodized Aluminum
 Heat Spreader: Copper
 Impedance: 50 Ohms



Part Number	Connector	Power (W)	Frequency (GHz)	VSWR (max)	Mechanical Outline
RFT10NXA	N-TYPE	10	DC-4.0 4.0-8.0 8.0-12.0	1.15:1 1.25:1 1.30:1	
RFT10NXE RFT10NXD RFT10NXC	N-TYPE		DC-2.0 DC-4.0 DC-8.0	1.10:1 1.15:1 1.20:1	
RFT15NXA	N-TYPE		15	DC-4.0 4.0-8.0 8.0-12.0	
RFT15NXE RFT15NXD RFT15NXC	N-TYPE	DC-2.0 DC-4.0 DC-8.0		1.10:1 1.15:1 1.20:1	

Dimensions are in inches [mm], Tolerance: .XXX = ±0.010, .XX = ±0.015

Ordering Information:

Example: **RFT 15 N X C**

Series ↑

Power (W) ↑

Connector Type ↑

B: BNC

N: N-Type

S: SMA

Gender ↑

M: Male

F: Female

Frequency Range Indicator ↑

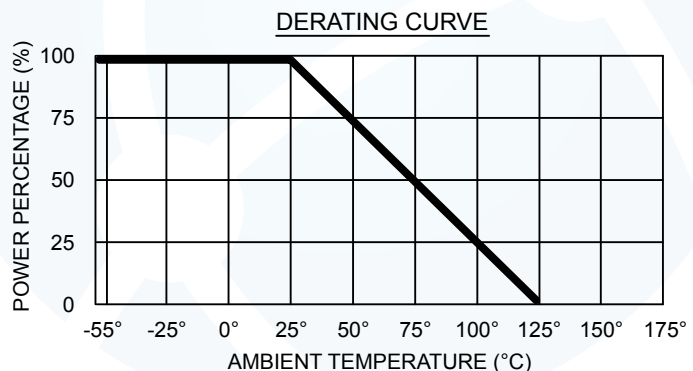

COAXIAL TERMINATIONS CONVECTION COOLED



General Specifications

Substrate: Beryllium Oxide
Resistive Material: Thick Film
Connector Body: N-Type, "SMA", and "BNC"
Connector Interface: Conforms to MIL-C-39012
Housing: Black Anodized Aluminum
Heat Spreader: Copper
Impedance: 50 Ohms



Part Number	Connector	Power (W)	Frequency (GHz)	VSWR (max)	Mechanical Outline
RFT25NXA	N-TYPE	25	DC-4.0 4.0-8.0 8.0-12.0	1.15:1 1.25:1 1.30:1	
RFT25NXE RFT25NXD RFT25NXC	N-TYPE		DC-2.0 DC-4.0 DC-8.0	1.10:1 1.15:1 1.20:1	
RFT50NXE RFT50NXD RFT50NXC	N-TYPE	50	DC-2.0 DC-4.0 DC-8.0	1.10:1 1.15:1 1.20:1	
RFT100NXE RFT100NXD	N-TYPE	100	DC-2.0 DC-4.0	1.10:1 1.15:1	

Ordering Information:

Example: **RFT 100 N X D**

Series ———— ↑
Power (W) ———— ↑
Connector Type ———— ↑
B: BNC
N: N-Type
Gender ———— ↑
M: Male
F: Female
Frequency Range Indicator ———— ↑

Dimensions are in inches [mm], Tolerance: .XXX = ±0.010, .XX = ±0.015

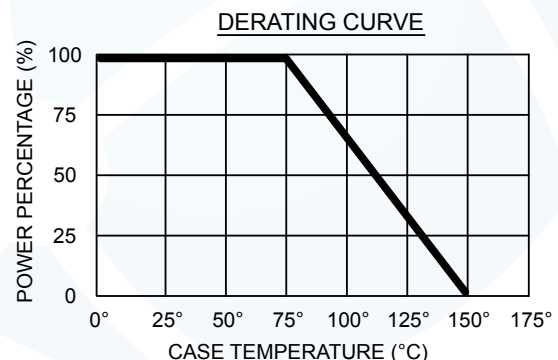

COAXIAL TERMINATIONS CONVECTION COOLED

General Specifications

Substrate: Beryllium Oxide
 Resistive Material: Thick Film
 Connector Body: N-Type, other Connections available upon request
 Connector Interface: Conforms to MIL-C-39012
 Housing: Black Anodized Aluminum
 Heat Spreader: Copper
 Impedance: 50 Ohms

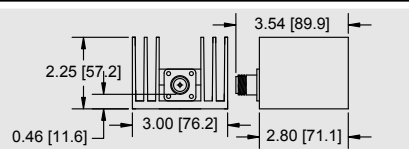
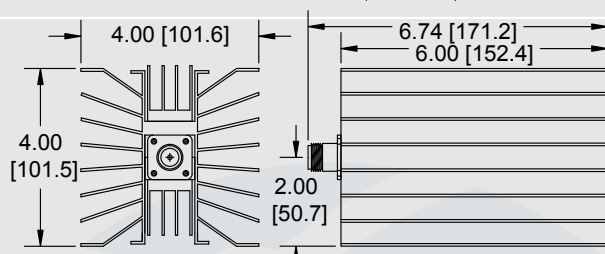
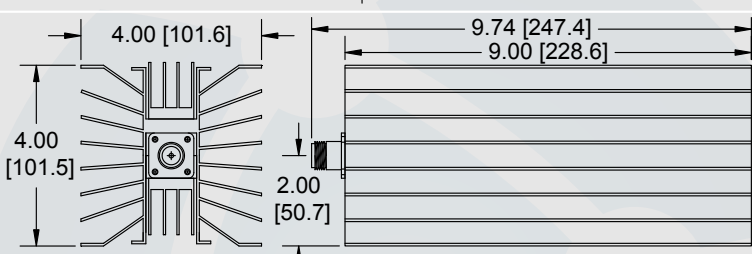
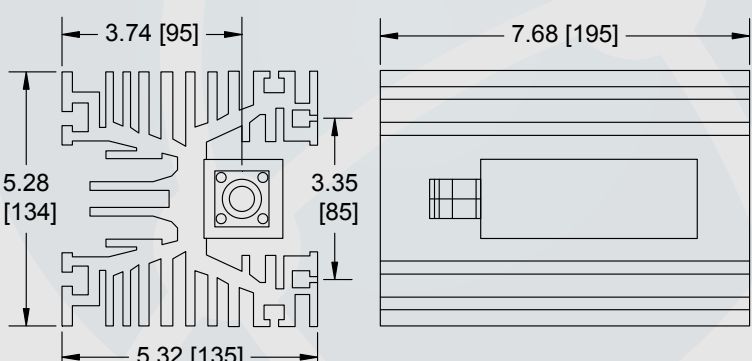

Part Number	Power (W)	Frequency (GHz)	VSWR (max)	Mechanical Outline
RFT30NF RFT60NF	30 60	DC-5.0 DC-5.0	1.20:1 1.20:1	
RFT100NF RFT150NF	100 150	DC-5.0 DC-5.0	1.20:1 1.20:1	
RFT250NF	250	DC-5.0	1.20:1	
RFT250NF-6 RFT250NM-6	250	DC-6.0	1.20:1	

Dimensions are in inches [mm], Tolerance: .XXX = ±0.010, .XX = ±0.015

COAXIAL TERMINATIONS CONVECTION COOLED



General Specifications

Substrate: Beryllium Oxide
 Resistive Material: Thick Film
 Connector Body: N-Type, other Connections available upon request
 Connector Interface: Conforms to MIL-C-39012
 Housing: Black Anodized Aluminum
 Heat Spreader: Copper
 Impedance: 50 Ohms



Part Number	Power (W)	Frequency (GHz)	VSWR (max)	Mechanical Outline
RFT500NF	500	DC-3.0	1.20:1	
RFT1000NF	1000	DC-3.0	1.20:1	
RFT1500NF	1500	DC-0.5	1.25:1	
RFT2000NF	2000	DC-0.5	1.25:1	

Dimensions are in inches [mm], Tolerance: .XXX = ±0.010, .XX = ±0.015

[Ordering Information on page 76](#)



General Specifications

Substrate: Alumina (3W), Beryllium Oxide (15W)
 Resistive Material: Thin Film
 Contact: Gold Plated Half Hard Beryllium Copper
 Housing: Nickel Plated Copper



Part Number	Impedance (Ohms)	Frequency (GHz)	VSWR (max)	Power (W)
RCL3-1	50	DC-4.0 4.0-8 8.0-18	1.10:1 1.20:1 1.35:1	3
RCL3-3				3
RCL3-4				3
RCL-15-1				15

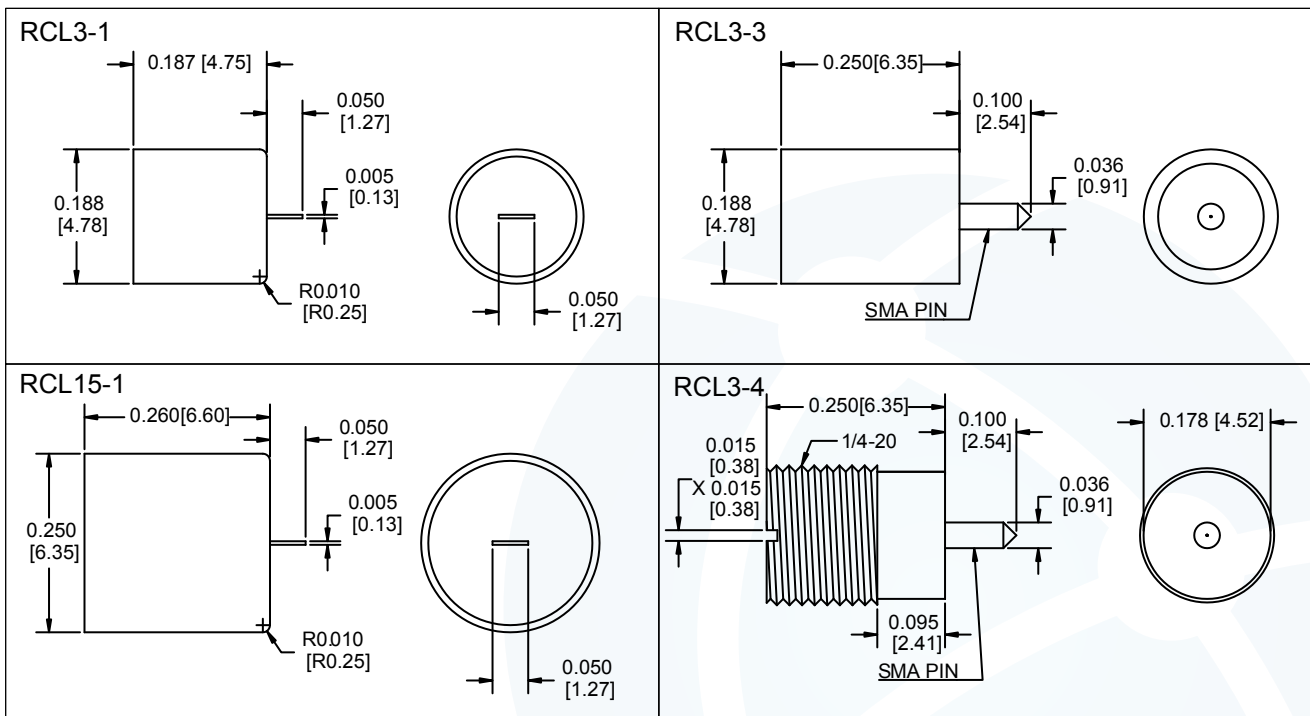

Dimensions are in inches [mm], Tolerance: .XXX = ±0.010, .XX = ±0.015

Ordering Information:

Example: **RCL 15 1**

Series → RCL
 Power → 15
 Tab (pin), housing configuration → 1

1: tab, standard housing
 3: pin, standard housing
 4: pin, threaded housing

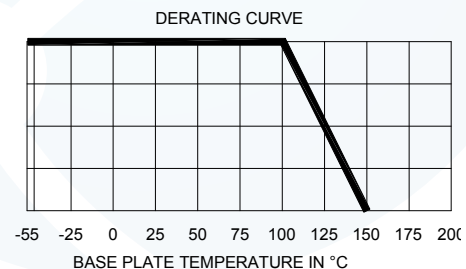

CVD DIAMOND COMPONENTS



CVD (chemical vapor deposition) synthetic diamond has outstanding thermal conductivity, 3 to 4 times better than copper. In addition, the low dielectric constant makes CVD diamond an excellent RF dielectric material for high-frequency and high power applications.

Combining advanced thin-film processing techniques and extensive high frequency design experience, Res-Net Microwave, Inc. has created a line of high performance CVD components that can withstand even the most challenging space environment.

Res-Net Microwave offers the highest quality resistors, terminations, and thermal jumpers on diamond substrate for unparalleled average and peak power handling.

The mechanical and electrical characteristics of these chips provide a robust solution for many aerospace and military applications, while their production process keeps the cost competitive for commercial use.



Features:

- Frequency range from DC to 30 GHz
- Small size and weight
- Extreme high power dissipation
- Peak power performance
- Solderable or bondable gold terminals
- High reliability versions available

Applications:

- Military
- Radar
- Broadcast
- High Power Amplifiers
- Isolators
- Satellite Communications



CVD DIAMOND CHIP RESISTORS

Res-Net CVD diamond resistors offer excellent power handling and high frequency performance. The superior thermal properties of CVD diamond (high conductivity and low expansion) makes these resistors ideal for pulsed power applications.

The mechanical and electrical characteristics of these chips provide a robust solution for many aerospace and military applications, while its production process keeps the cost competitive for commercial use.

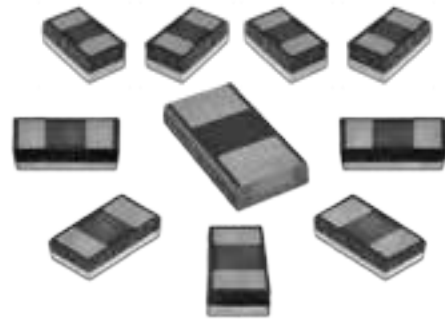

Part Number	Size L x W x H (Inches)	Frequency (GHz)	Power (W)	Capacitance typ. (pF)
RPC0402DR	0.025 x 0.045 x 0.015	DC – 30	20	0.1
RPC0603DR	0.065 x 0.035 x 0.015	DC – 20	50	0.2
RPC0805DR	0.085 x 0.055 x 0.015	DC – 18	100	0.3
RPC1310DR	0.130 x 0.100 x 0.015	DC – 18	150	0.8

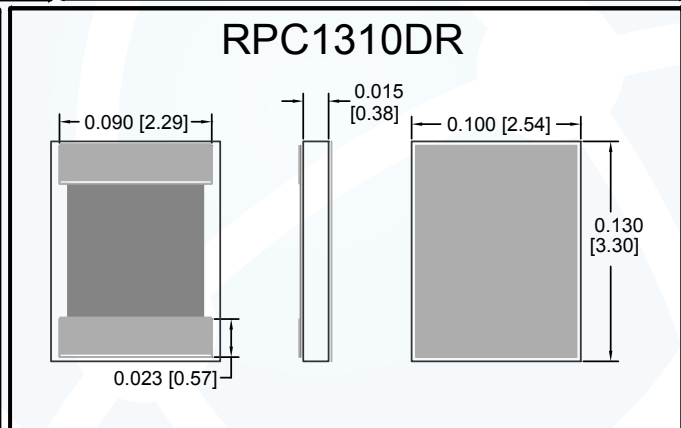
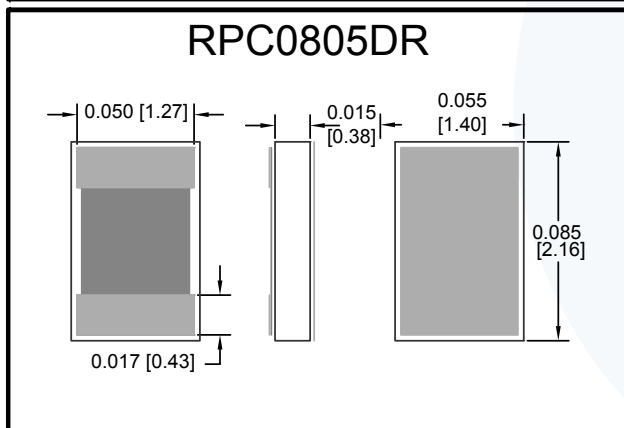
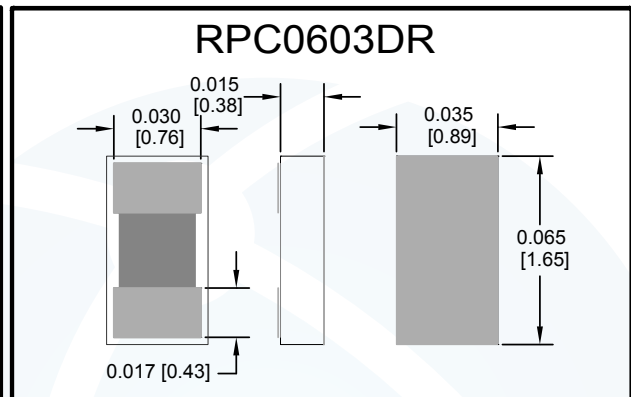
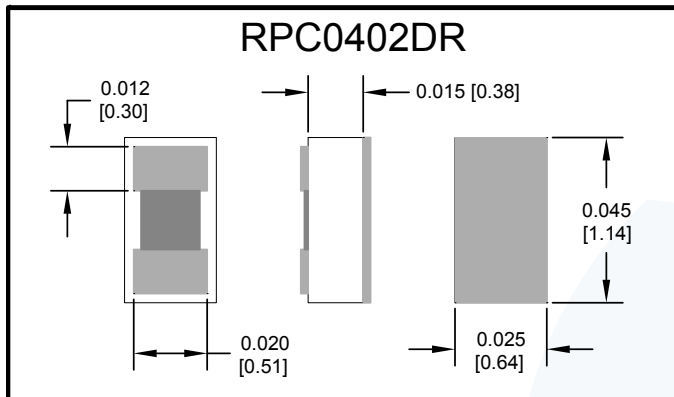

[Ordering Information on Page 82](#)

Dimensions are in inches [mm], Tolerance: .XXX = ±0.010, .XX = ±0.015

CVD DIAMOND CHIP RESISTORS



Ordering Information:

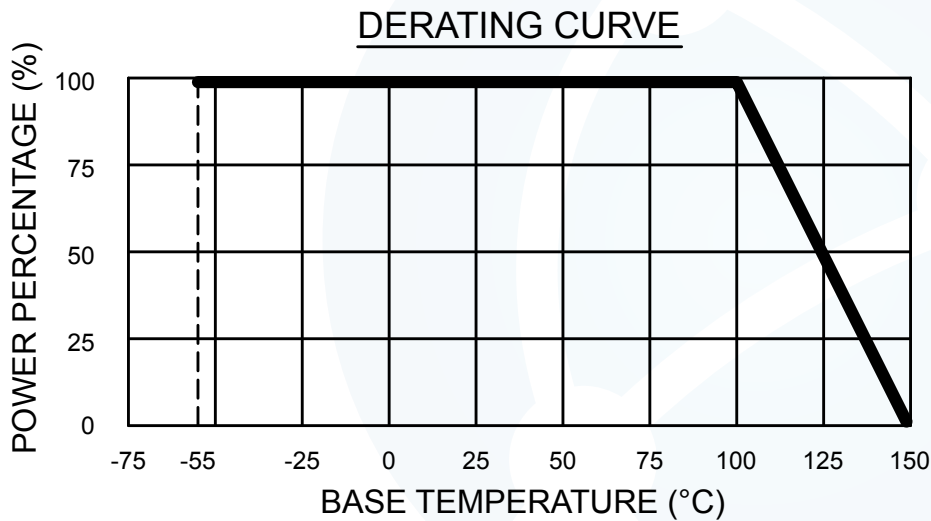
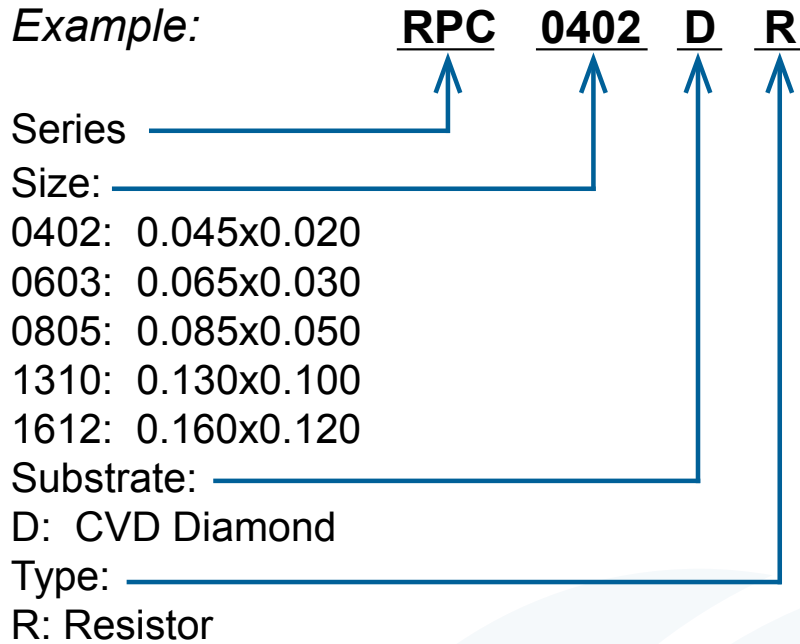

CVD DIAMOND CHIP TERMINATIONS

Res-Net CVD diamond Terminations offer excellent power handling and high frequency performance. The superior thermal properties of CVD diamond (high conductivity and low expansion) makes these terminations ideal for pulsed power applications.

The mechanical and electrical characteristics of these chips provide a robust solution for many aerospace and military applications, while its production process keeps the cost competitive for commercial use.

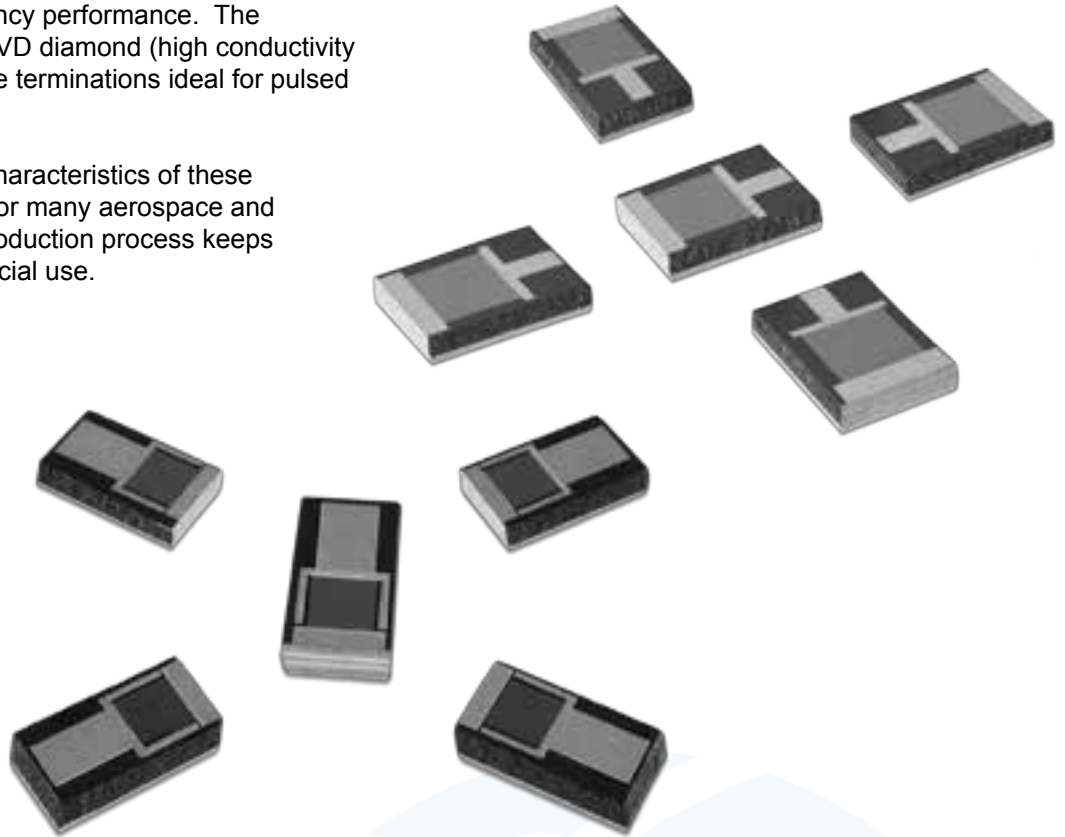

Part Number	Size L x W x H (Inches)	Frequency (GHz)	Max VSWR	Power (W)
RPC0402DT	0.025 x 0.045 x 0.015	DC – 10	1.5:1	15
RPC0603DT	0.065 x 0.035 x 0.015	DC – 26.5	1.5:1	50
RPC0805DT	0.085 x 0.055 x 0.015	DC – 18	1.5:1	100
RPC1310DT	0.130 x 0.100 x 0.015	DC – 14	1.4:1	150
RPC1612DT	0.160 x 0.120 x 0.015	DC - 6	1.25:1	300

[Ordering Information on Page 86](#)

CVD DIAMOND CHIP TERMINATIONS

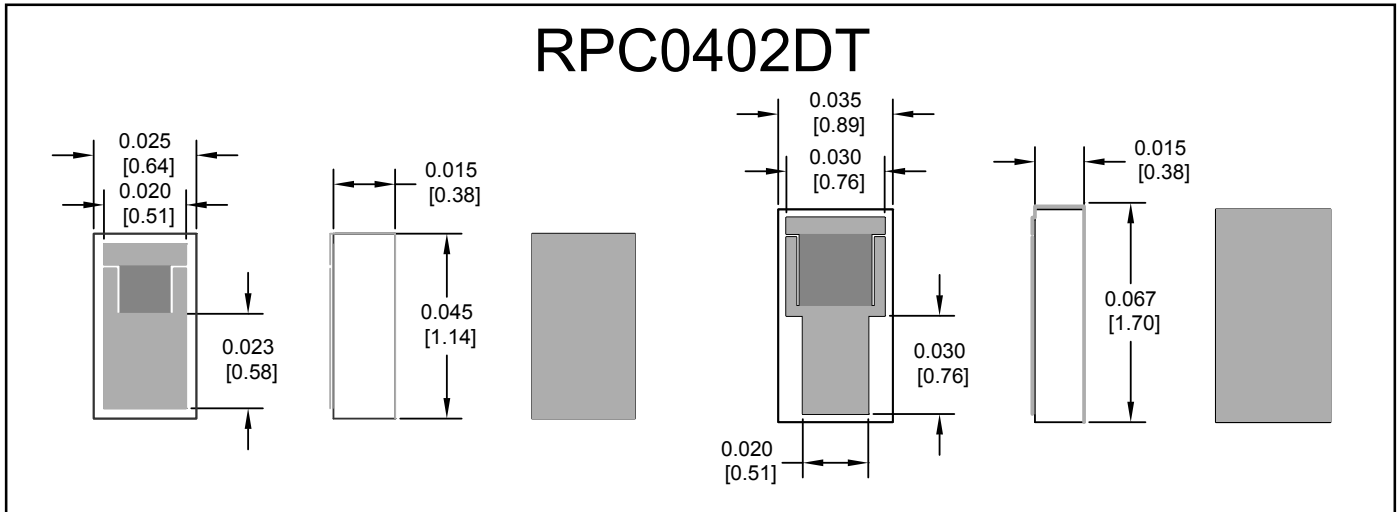

RPC0603DT

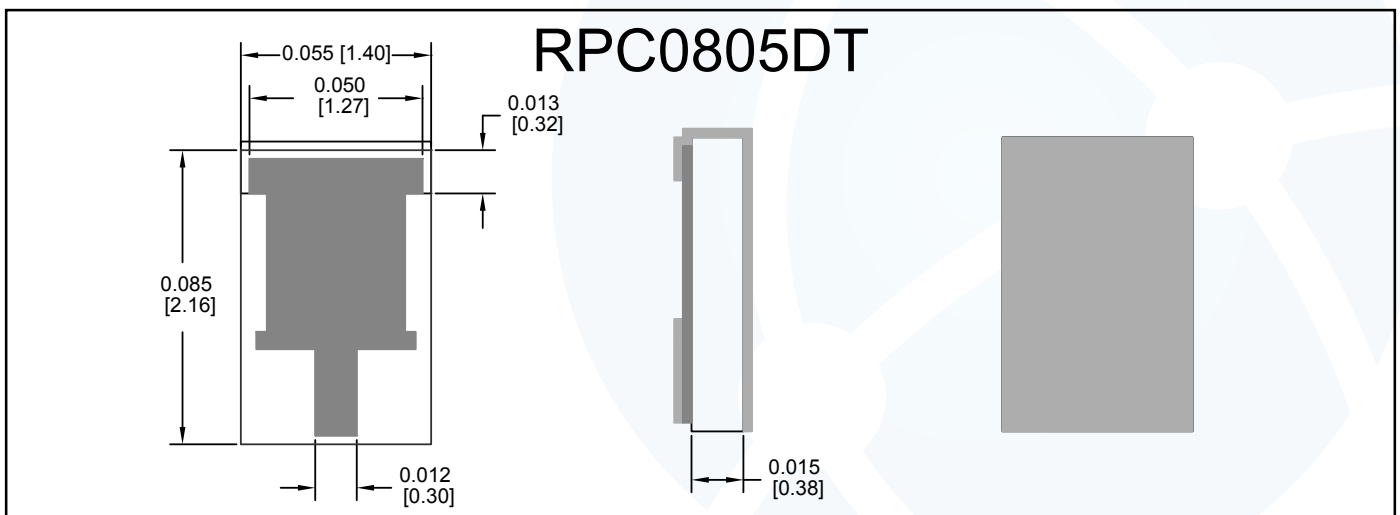
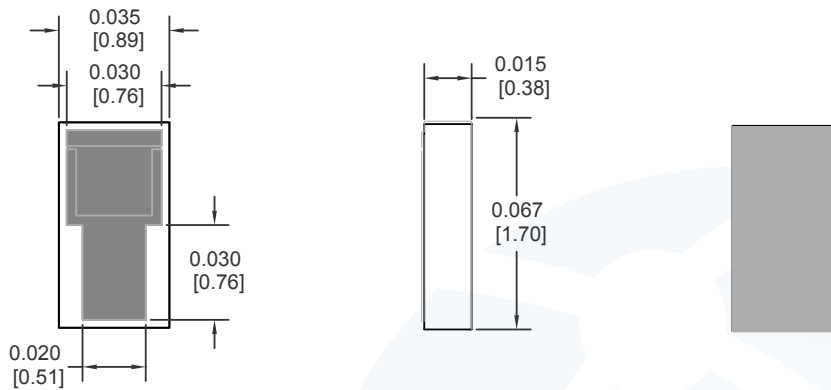

[Ordering Information on Page 86](#)

Dimensions are in inches [mm], Tolerance: .XXX = ±0.010, .XX = ±0.015



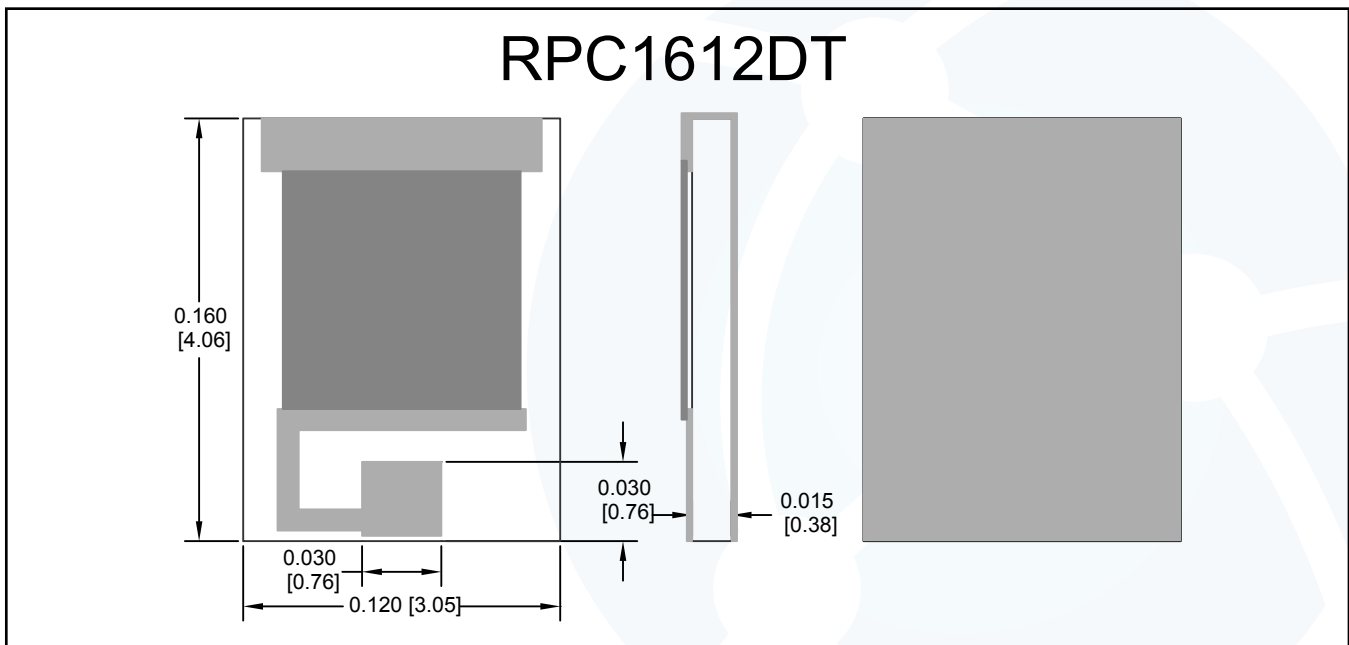
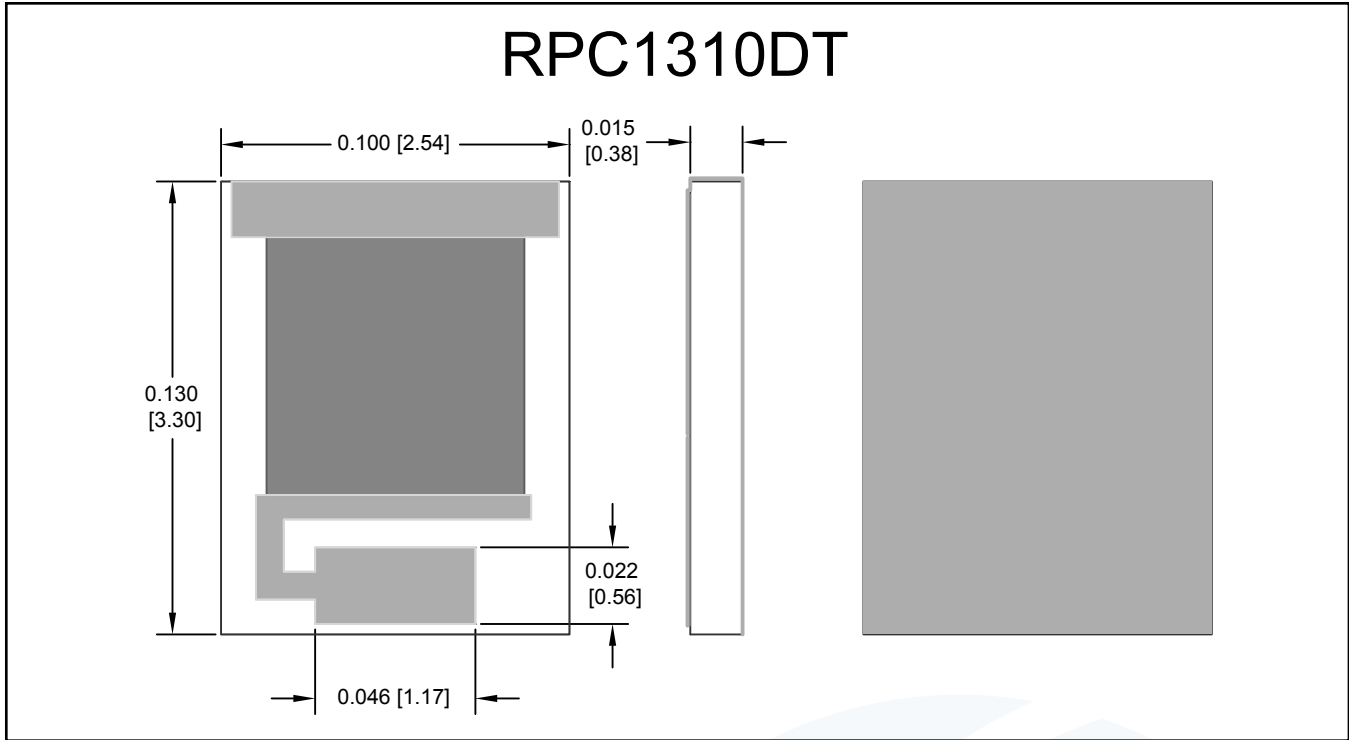

Dimensions are in inches [mm], Tolerance: .XXX = ± 0.010 , .XX = ± 0.015

[Ordering Information on Page 86](#)

CVD DIAMOND CHIP TERMINATIONS



Ordering Information:

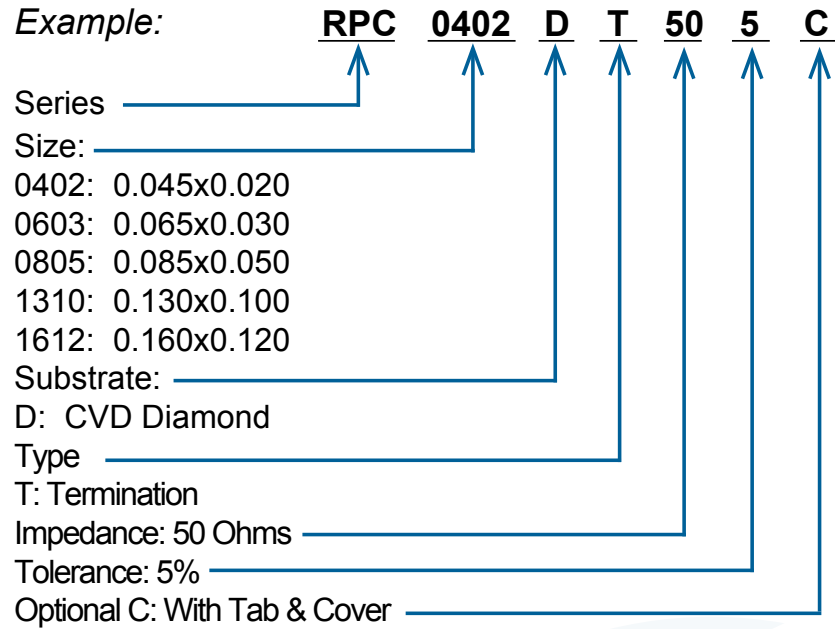

DERATING CURVE

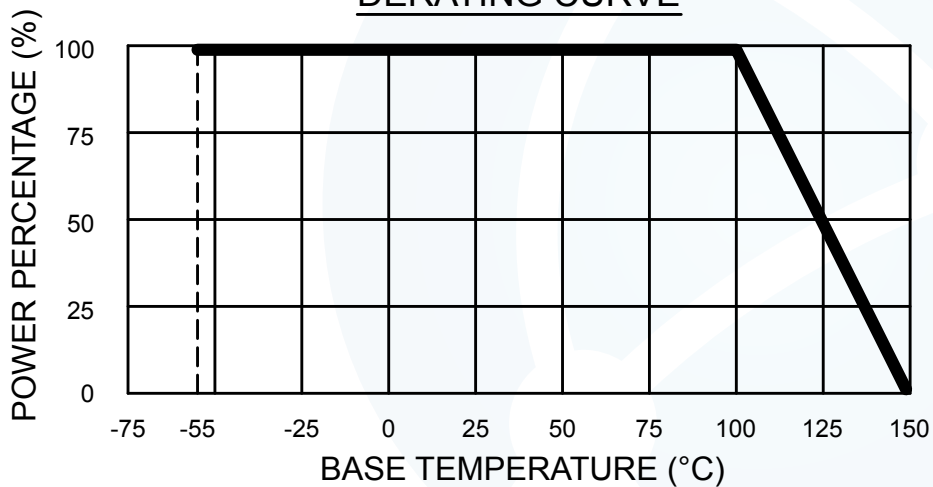

TERMINATIONS

CVD DIAMOND FLANGE CONNECTORS

General Specifications

Substrate: CVD Diamond
 Resistive Material: Thin Film
 Tabs: Silver Plated Beryllium Copper
 Flange: Nickel Plated Copper
 Temperature Range: -55°C to +150°C
 Impedance: 50 ohms ±5%



Part Number	Frequency (GHz)	VSWR (max)	Power (W)
RPC0603DT-FL	DC-26.5	1.5:1	50
RPC0805DT-FL	DC-24	1.5:1	100
RPC1310DT-FL	DC-14	1.4:1	150
RPC1612DT-FL	DC-6	1.25:1	300

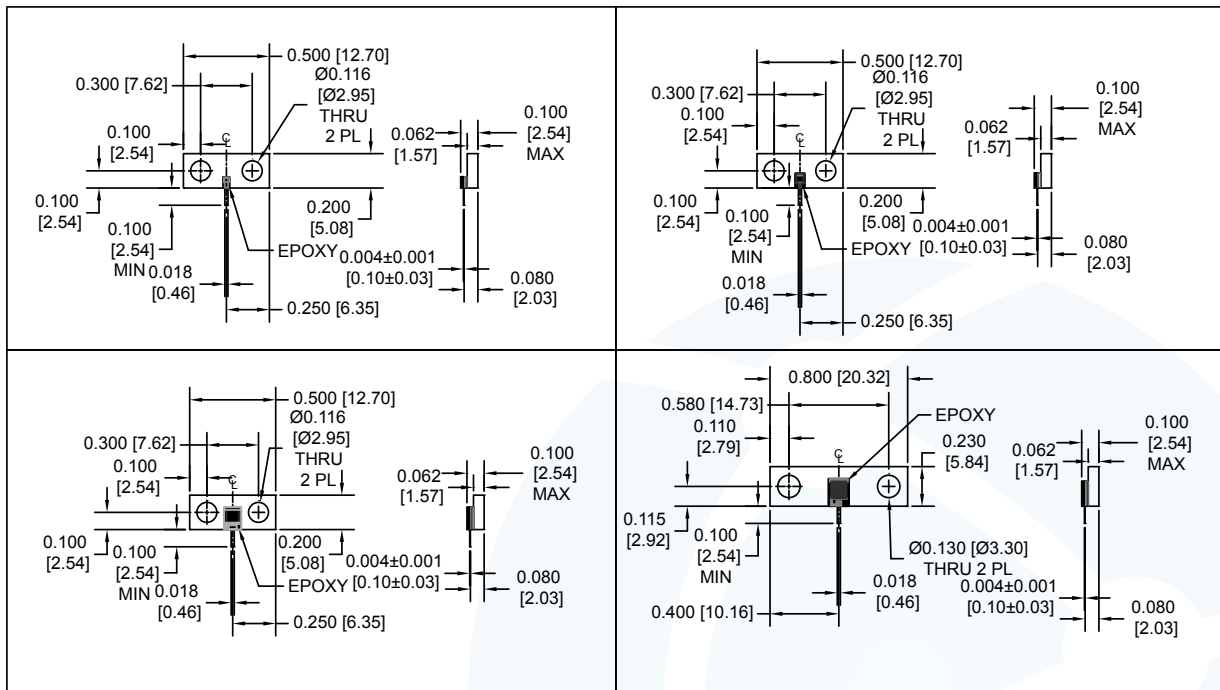

Ordering Information:

Example: **RPC 0402 D - FL**

Series: _____
 Size: _____
 0603: 0.065x0.030
 0805: 0.085x0.050
 1310: 0.130x0.100
 1612: 0.160x0.120
 Substrate: _____
 D: CVD Diamond
 Type: _____
 T: Termination
 FL: Flange

Dimensions are in inches [mm]
 Tolerance: .XXX = ±0.010
 .XX = ±0.015

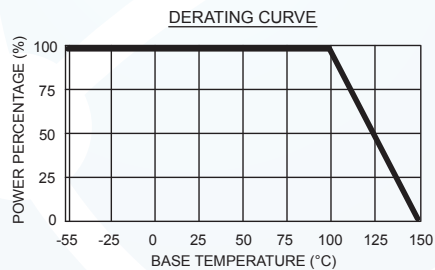

TERMINATIONS CVD COAXIAL



General Specifications

Substrate: CVD Diamond
Resistive Material: Thin Film
Connector Body: SMA Passivated Stainless Steel
Housing: Nickel Plated Copper



Part Number	Impedance (Ohms)	Frequency (GHz)	Max VSWR	Temperature Range	Power (W)
RCX-SF30E	50	DC-27	1.30:1	-55° to +150°C	30

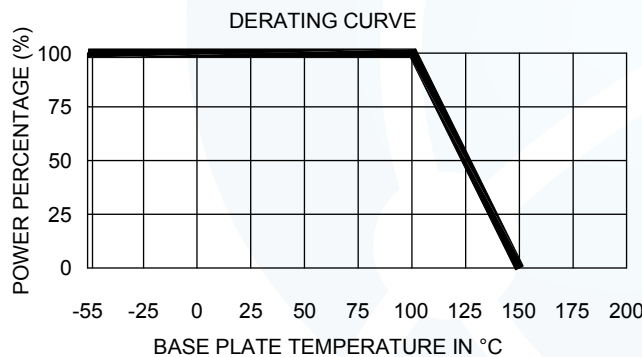
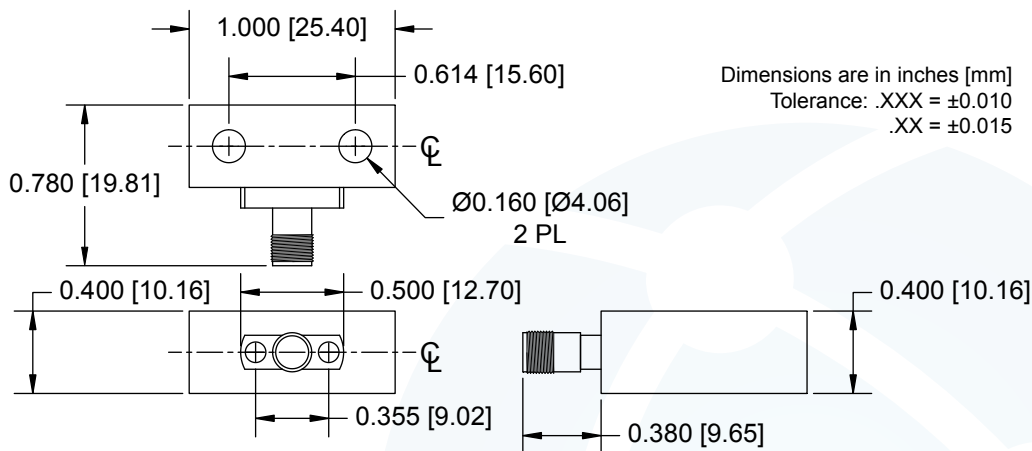

[Ordering Information on Page 87](#)



These ceramic chips are designed to help in thermal management by transferring the heat from components to an area on the PCB where it can be safely dissipated.

The thermal jumpers are electrically isolated and can be used in both, RF and DC applications.

The Thermal Jumpers can be mounted between the chassis (or flange) of the heat source and an external heat sink providing a conduction path for the heat transfer creating a design alternative for systems where temperature cannot be controlled by forcing mechanisms like fans or water cooling systems.

Our thermal jumpers are RoHS compliant. See following pages for CVD Diamond, ALN and BeO.

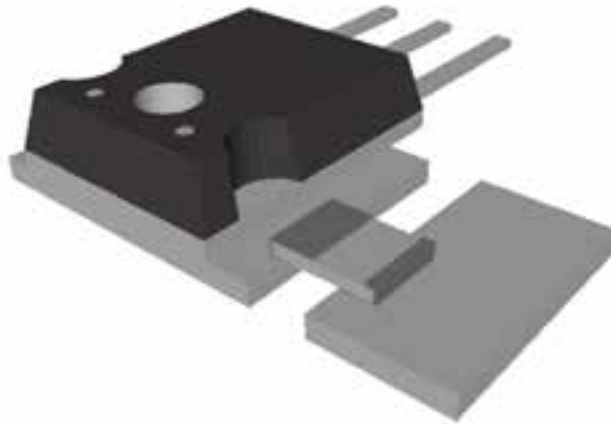

THERMAL JUMPERS CVD DIAMOND



The thermal jumpers are electrically isolated and can be used in both, RF and DC applications.

See page 107 regarding extended metalization.

Our thermal jumpers are RoHS compliant. See following pages for ALN and BeO.

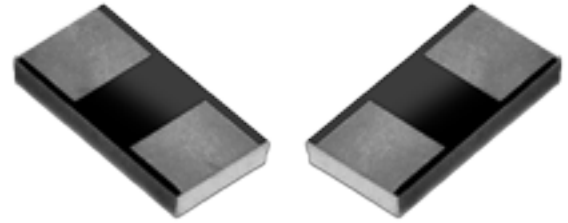

CVD Diamond

Part Number	Length (in)	Width (in)	Thickness (in)	Thermal Resistance (°C/W)
RTC0505-15DS	0.050	0.050	0.015	2.62
RTC0603-15DS	0.060	0.030	0.015	5.25
RTC0805-15DS	0.080	0.050	0.015	4.2
RTC1005-15DS	0.100	0.050	0.015	5.25
RTC1206-15DS	0.120	0.060	0.015	5.25
RTC1020-15DS	0.100	0.200	0.015	1.31
RTC236200-15DS	.236	.200	0.015	3.10

Ordering Information:

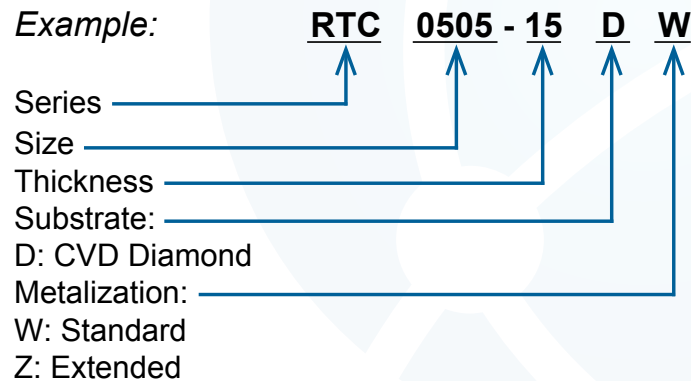

The thermal jumpers are electrically isolated and can be used in both, RF and DC applications.

Metalization options: The thermal jumpers are offered with standard or extended metalization. See page 107 regarding extended metalization.

Our thermal jumpers are RoHS compliant.

Standard Metalization:

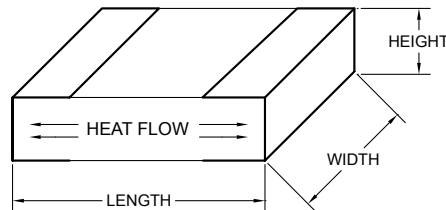

Aluminum Nitride

Part Number	Length (in)	Width (in)	Thickness (in)	Thermal Resistance (°C/W)	Capacitance (pF)
RTC0505-25NW	0.050	0.050	0.025	9.2	0.150
RTC0603-25NW	0.060	0.030	0.025	18	0.075
RTC0805-25NW	0.080	0.050	0.025	15	0.070
RTC1005-25NW	0.100	0.050	0.025	18	0.042
RTC1206-25NW	0.120	0.060	0.025	18	0.038
RTC1020-25NW	0.100	0.200	0.025	4.63	0.170

Ordering Information:

Example:

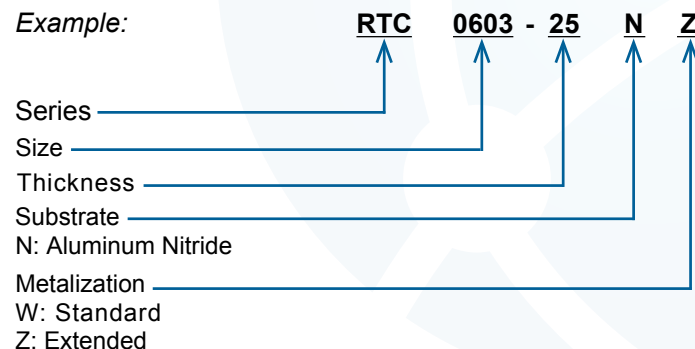

THERMAL JUMPERS

ALUMINUM NITRIDE (ALN)



Extended Metalization: The extended metalization provides added heat transfer by increasing the effective area in the thermal path. This increased metalization will also increase the capacitance. This type of metalization is recommended for DC applications.

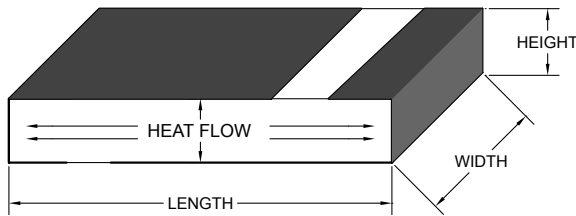

Aluminum Nitride					
Part Number	Length (in)	Width (in)	Thickness (in)	Thermal Resistance (°C/W)	Capacitance (pF)
RTC0603-25NZ	0.060	0.030	0.025	4.3	0.200
RTC0805-25NZ	0.080	0.050	0.025	1.9	0.300
RTC1206-25NZ	0.120	0.060	0.025	0.9	0.600
RTC1020-40NZ	0.100	0.200	0.040	0.7	1.100

Ordering Information:

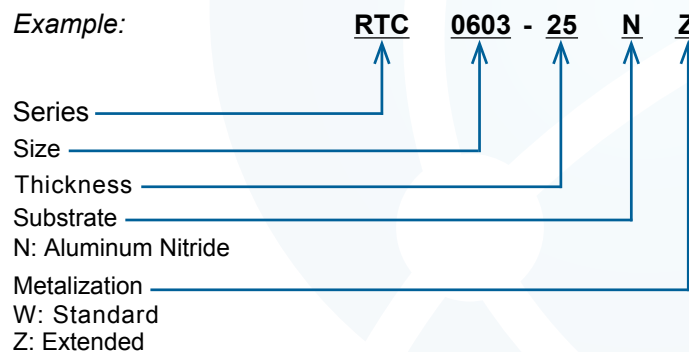

THERMAL JUMPERS

BERYLLIUM OXIDE (BeO) CONNECTORS

The thermal jumpers are electrically isolated and can be used in both, RF and DC applications.

Metalization options: The thermal jumpers are offered with standard or extended metalization.

Res-Net thermal jumpers are RoHS compliant and are BeO with different sizes and thickness.

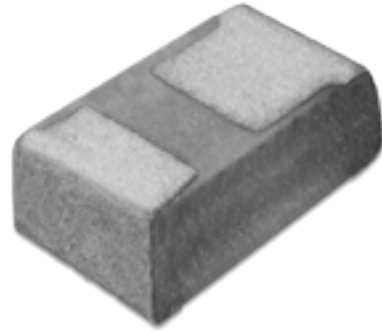

Beryllium Oxide (Standard W)					
Part Number	Length (in)	Width (in)	Thickness (in)	Thermal Resistance (°C/W)	Capacitance (pF)
RTC0505-25W	0.050	0.050	0.025	6.06	0.183
RTC0603-25W	0.060	0.030	0.025	12.11	0.055
RTC0805-25W	0.080	0.050	0.025	9.69	0.046
RTC1005-25W	0.100	0.050	0.025	12.11	0.030
RTC1206-25W	0.120	0.060	0.025	12.11	0.027
RTC1020-25W	0.100	0.200	0.025	3.03	0.122

Beryllium Oxide (Z Style)					
Part Number	Length (in)	Width (in)	Thickness (in)	Thermal Resistance (°C/W)	Capacitance (pF)
RTC0505-25Z	0.050	0.050	0.025	2.02	0.256
RTC0603-25Z	0.060	0.030	0.025	2.78	0.116
RTC0805-25Z	0.080	0.050	0.025	1.21	0.206
RTC1005-25Z	0.100	0.050	0.025	0.93	0.250
RTC1206-25Z	0.120	0.060	0.025	0.63	0.361
RTC1020-25Z	0.100	0.200	0.025	0.23	0.998

Ordering Information:

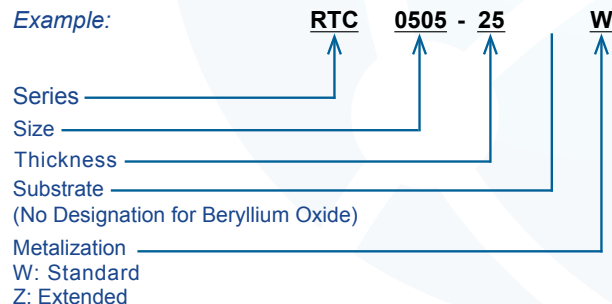

ZERO-BIASED SCHOTTKY DIODE DETECTOR RNZD SERIES CONNECTORS



General Information:

The RNZD series of diode detectors offers a low junction capacitance and excellent sensitivity and bandwidth. The response of the RNZD diode detectors is an order of magnitude faster than conventional PN diodes making them ideal for use in RF and microwave applications.

Features:

- Low Junction Capacitance
- Broadband Performance
- Low VSWR
- Excellent Flatness
- Positive or Negative Polarity

Applications:

- Power and Signal Monitoring
- Transmitter Monitoring
- Radar and Missile Guidance Systems
- Test Equipment
- Medical Equipment

Electrical Specifications Universal:

- Maximum Power Input: 100mW
- Video Resistance: 5K Ohms
- Operating/Storage Temperature Range: -55 °C to +120°C

Part Number	Frequency (GHz)	VSWR (max)	Voltage Sensitivity (K-factor) (mV/mW) TYP	Flatness (dB)	Video Capacitance (pF)
RNZD01-2	0.01 to 2	1.2:1	500	±0.20	470
RNZD01-4	0.01 to 4	1.3:1	500	±0.30	470
RNZD01-12	0.01 to 12.4	1.4:1	500	±0.30	470
RNZD01-18	0.01 to 18.5	1.5:1	400	±0.50	470
RNZD01-26	0.01 to 18 18 to 26.5	1.5:1 2.0:1	100	±0.50 ±1.0	470
RNZD02-18	2 to 18	1.5:1	500	±0.40	20
RNZD02-4	2 to 4	1.2:1	500	±0.20	20
RNZD02-8	2 to 8	1.2:1	500	±0.20	20

[Ordering Information on Page 96](#)



ZERO-BIASED SCHOTTKY DIODE DETECTOR

RNZD SERIES "HIGH SENSITIVITY"



Part Number	Frequency (GHz)	VSWR (max)	Voltage Sensitivity (K-factor) (mV/mW) TYP	Flatness (dB)	Video Capacitance (pF)
RNZD01-2S	0.01 to 2	4.5:1	1200	±0.50	470
RNZD01-4S	0.01 to 4	3.5:1	1200	±0.80	470
RNZD01-12S	0.01 to 12.4	3.5:1	1000	±1.00	470
RNZD01-18S	0.01 to 18.5	4.5:1	1000	±1.00	470
RNZD01-26S	0.01 to 26	4.5:1	500	±1.50	470
RNZD02-4S	2 to 4	3.5:1	1200	±0.50	20
RNZD02-8S	2 to 8	3.5:1	1000	±0.50	20
RNZD02-18S	2 to 18	4.5:1	1000	±1.00	20
RNZD06-18S	6 to 18	4.5:1	1000	±1.00	10
RNZD08-18S	8 to 18	4.5:1	1000	±1.00	10

ZERO-BIASED SCHOTTKY DIODE DETECTOR RNZD SERIES CONNECTORS

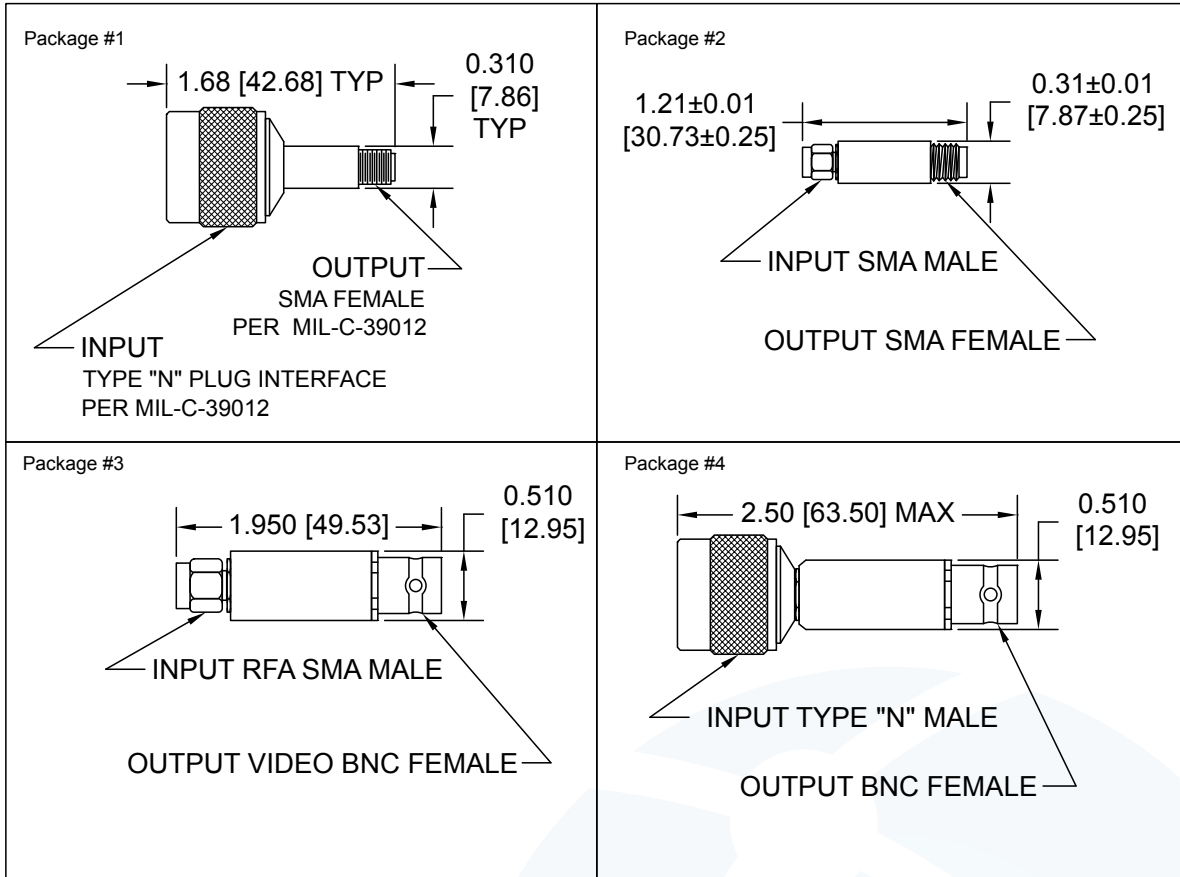

Dimensions are in inches [mm]
 Tolerance: .XXX = ±0.010
 .XX = ±0.015

Ordering Information:

Example: **RN****ZD** **01** - **18** **S** **N** **2** **F****

Series Number
 MIN Frequency*
 MAX Frequency*
 S: High Sensitivity
 (No Indicator for Standard)
 Polarity
 N: Negative
 P: Positive
 Package Style
 1: N (M) to SMA (F)
 2: SMA (M) to SMA (F)
 3: SMA (M) to BNC (F)
 4: N (M) to BNC (F)
 Gender I/O
 F: Female Input / Male Output
 (No Indicator for Standard Male Input / Female Output)

*See Tables for Available Values
 12.4 GHz = 12; 26.5 GHz = 26



CERTIFICATIONS

Quality program to ANSI/NCSS Z 540, MIL-STD-790,

- ISO 9001: 2008, Certificate No. CERT-0087564

The design and manufacture of printed board mounted components, transformers, resistors, inductors and microwave components. Additional manufacturing and internal audits are conducted at Zona Franca BES Edificio # 16 Coyo De, Alajuela, CRI, 16 (Site# 1602263).

- NASA Specification NPC 200-3.
- Calibration to MIL-STD-45662 requirements.
- In-house photo etch and laser trim capabilities
- Large choice of substrate materials.

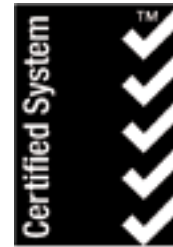

SAI GLOBAL
ISO 9001
Quality

WARRANTY

RES-NET MICROWAVE warrants each product to be free from any defect in material and workmanship for a period of one year after delivery to the original purchaser. Returns must be authorized by a factory representative. Limit and liability shall be to repair or replace the defective part. This warranty shall not apply to any product that has been disassembled, modified, or electrically damaged or subjected to conditions exceeding the specifications. We reserve the right to make design and / or specification changes without notice.

*This catalog
is dedicated in
loving memory of
Roger C. Mayo
1932 - 2014*

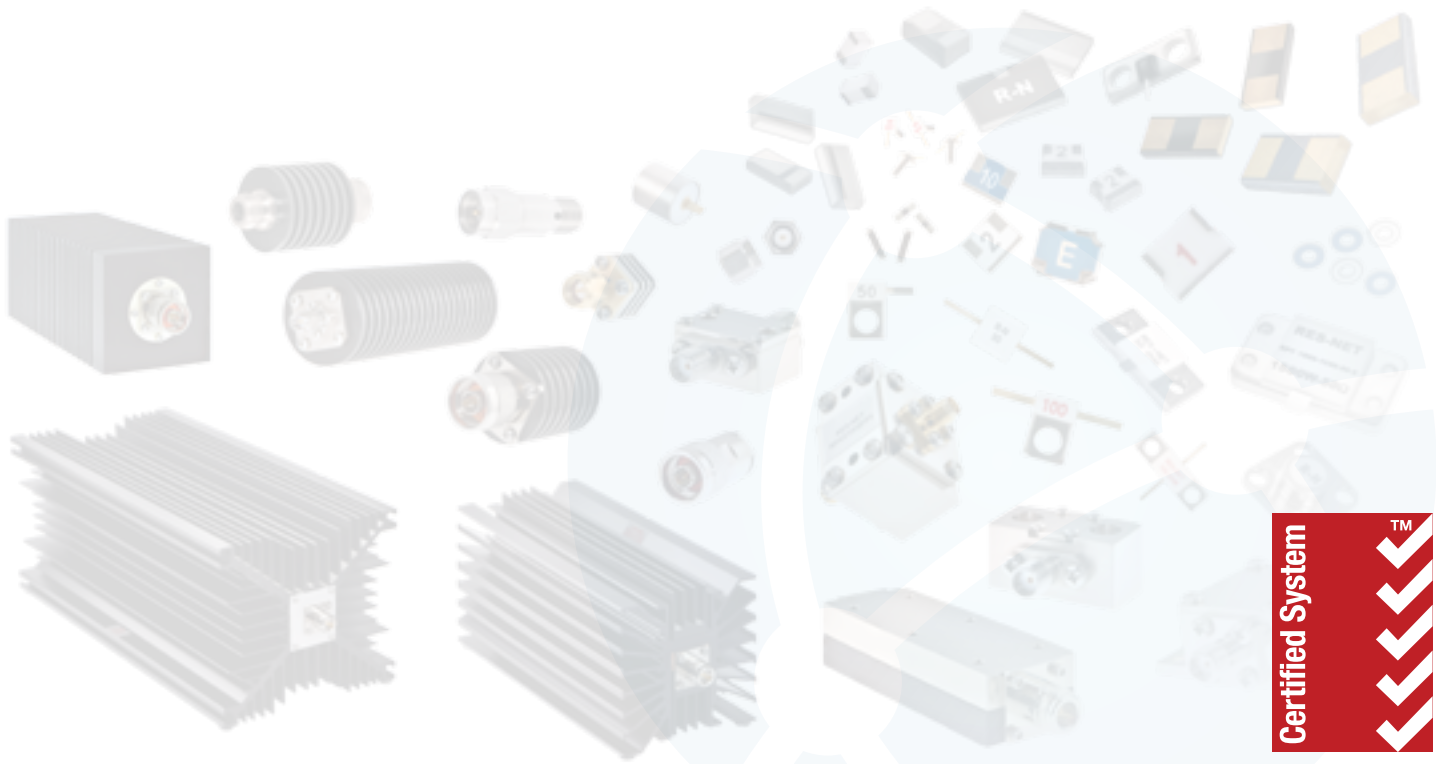

SAI GLOBAL
ISO 9001
Quality

Microwave Products

Res-Net Microwave, Inc.

P.O. Box 18802, Clearwater, FL 33762

tel: **727-530-9555**

fax: 727-531-8215

res_sales_service@electrotechnik.com

www.resnetmicrowave.com

- RF/Microwave Resistors, Attenuators, Terminations

Nova Microwave, Inc.

P.O. Box 18802, Clearwater, FL 33762

tel: **408-778-2746**

fax: 727-531-8215

novasales@electrotechnik.com

www.novamicrowave.com

- RF/Microwave Isolators and Circulators

Star Microwave, Inc.

P.O. Box 18802, Clearwater, FL 33762

tel: **727-530-9555**

fax: 727-531-8215

starsales@electrotechnik.com

www.starmicrowave.net

- Custom Ferrite Isolators and Circulators

Capacitive Products

Arizona Capacitors, Inc.

1100 S. Plumer Avenue, Tucson, AZ 85719

tel: **520-573-0221** fax: 520-573-0520

azcapsales@electrotechnik.com

www.arizonacapacitors.com

- Wound Film Capacitors and Electronic Filters

Custom Suppression, Inc.

1100 S. Plumer Avenue, Tucson, AZ 85719

tel: **520-573-0223** fax: 520-573-0520

csisales@electrotechnik.com

www.customsuppression.com

- Broadband, Microwave, EMI, and RFI Filters,
Filtered Connectors, and Assemblies

Plastic Capacitors, Inc.

1100 S. Plumer Avenue, Tucson, AZ 85719

tel: **520-573-0221** fax: 520-573-0520

E-mail: sales@plasticcapacitors.com

Web: www.plasticcapacitors.com

- High Voltage Capacitors



Resistive Products

Tepro of Florida, Inc.

P.O. Box 18802, Clearwater, FL 33762

tel: **727-796-1044**

fax: 727-791-7425

tep_sales_service@electrotechnik.com

www.tepro-vamistor.com

- Wirewound and Metal Film Resistors

Vamistor Corporation

P.O. Box 1260, Clearwater, FL 33757

tel: **727-796-1044** fax: 727-791-7425

tep_sales_service@electrotechnik.com

www.tepro-vamistor.com

- Carbon Film and RL 42 Resistors

HYMEG Corporation

P.O. Box 18802, Clearwater, FL 33762

Phone: **800-322-1953**

E-mail: sales@hymeg.com

Web: www.hymeg.com

- High Voltage Resistors

Magnetics Products

Hytronics Corporation

P.O. Box 18802, Clearwater, FL 33762

tel: **727-535-0413**

fax: 727-531-1592

hy_sales_service@electrotechnik.com

www.hytronicscorp.com

- Power Transformers and Power Inductors

Raycom Electronics, Inc.

P.O. Box 250, 1 Raycom Rd.

Dover, PA 17315

tel: **717-292-3641**

fax: 717-292-2919

raycomsaleservice@electrotechnik.com

www.raycomelectronics.com

- Custom Military and Avionics Magnetics

Inductive Technologies, Inc. (I-Tech)

P.O. Box 18802, Clearwater, FL 33762

tel: **727-532-4459**

fax: 727-531-1592

i-techsales@electrotechnik.com

www.inductech.com

- Standard Catalog Inductors and Transformers

Winatic Corporation

P.O. Box 18802, Clearwater, FL 33762

tel: **727-538-8917**

fax: 727-531-1592

win_sales_service@electrotechnik.com

www.winatic.com

- Transformers and Inductors for Medical Devices and Equipment

Cat: RCM-0417